

# COLD SYSTEM



**Molto più  
di quello che vedi**

*Much more  
than meets the eye*



THERMOPLASTIC EXTRUSION AND INJECTION MOULDING



## Sommario

Summary

1	<b>Profili angoli sanitari</b> Covings sanitary profiles	04
2	<b>Profilo battiscopa sanitario</b> Rounded plinth profile	08
3	<b>Basi pavimento</b> U channel profiles	10
4	<b>Profili porta guarnizione</b> Strip-holding profiles	14
5	<b>Profili per porte</b> Doors profiles	16
6	<b>Profili telaio</b> Frames profiles	18
7	<b>Profili per pannelli</b> Profiles for panels	20
8	<b>Sistemi di fissaggio</b> Fixing systems	22
9	<b>Profili paracolpi</b> Bumpers	24
10	<b>Tubi e distanziali per pannelli e pavimenti</b> Tubes and spacers for panels and floors	28
11	<b>Profili porta prezzi</b> Price holder profiles	30
12	<b>Guarnizioni per banchi e vetrine</b> Gaskets for cabinets and display	32

## Eccellenza dal 1955

Excellence since 1955

**Lombardini è leader nel settore dell'estrusione e stampaggio di materie plastiche, è attiva sul mercato dal 1955.**

**Lombardini is a leader in the field of plastics extrusion and moulding, it is active in the market since 1955.**

Lombardini produce profili mono-estrusi, co-estrusi e tri-estrusi standard e personalizzati per molteplici settori applicativi, tra i quali la **REFRIGERAZIONE INDUSTRIALE, IL SETTORE ALIMENTARE E SANITARIO, LA GRANDE DISTRIBUZIONE.**

La gamma di prodotti comprende: profili angolari, battiscopa, basi pavimento, profili per pannelli, profili per telaio e per porte, profili porta guarnizioni, bumpers, profili porta prezzi e guarnizioni per banchi frigo.

*Lombardini produces standard and customized mono-extruded, co-extruded and tri-extruded profiles for a wide range of application sectors, including INDUSTRIAL REFRIGERATION, FOOD AND SANITARY APPLICATIONS, BIG DISTRIBUTION.*

*The catalogue includes: covings sanitary profiles, plinth profile, U channel profiles, profiles for panels, frames profiles, profiles for doors, strip-holding profiles, bumpers, price holders profiles and gaskets for cabinets.*



**Elevati standard qualitativi**  
Top quality standards



**Montaggio rapido**  
Quick assembly



**Robustezza**  
Strong structure



**Economicità e funzionalità**  
Economy and functionality



**Materiali di prima qualità  
in classe VO norma UL94**  
1st quality raw materials in  
class VO regulation UL94



**Certificazione ISO 9001-2015**  
ISO 9001-2015 certification



# PROFILI ANGOLI SANITARI

## COVINGS SANITARY PROFILES

Sono dotati di un supporto in resina termoplastica o in alluminio per consentire fissaggi strutturali tra pareti, soffitti e pavimenti. I profili sono completi di particolari stampati che consentono un rapido assemblaggio ed una efficace finitura. I modelli dotati di ali morbide garantiscono altissimi livelli di igiene.

Provided with supports of thermoplastic resin or aluminium to allow fixing between walls, ceiling and floor. The profiles are also equipped with plastic elements for quick mounting and finishing. Models with soft edges ensure top sanitary level.



### SUPPORTI IN PVC / PVC SUPPORT

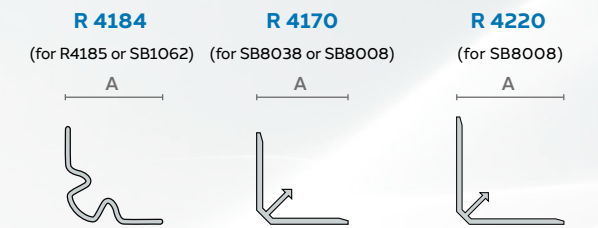

ARTICOLO ITEM	A mm	CONFEZIONI PACKAGING	MATERIALI MATERIALS	LUNGHEZZA LENGTH mm	COLORI COLORS
R 4170	30	25 pz / pcs	PVC	Standard 4000	Standard RAL 9010 RAL 9002
R 4184	30	70 pz / pcs	PVC		
R 4220	40	25 pz / pcs	PVC		

### ANGOLI SANITARI / COVINGS PROFILES

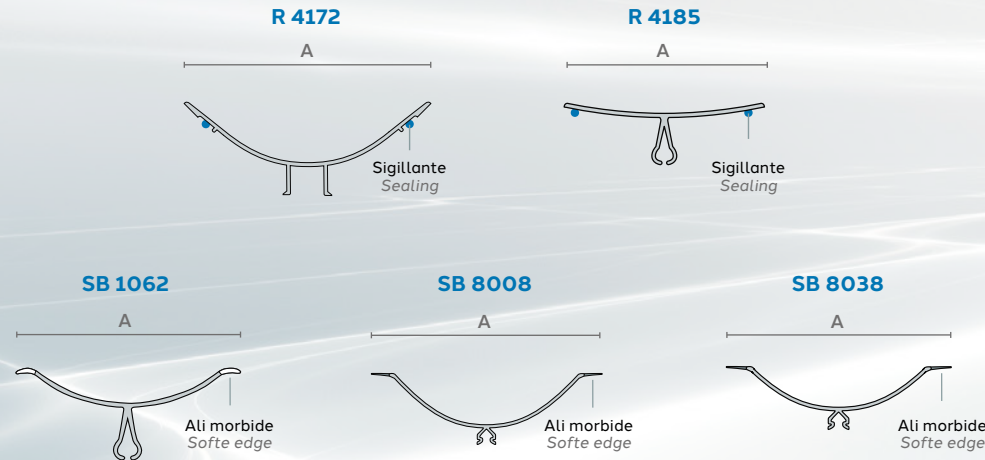

ARTICOLO ITEM	A mm	CONFEZIONI PACKAGING	MATERIALI MATERIALS	LUNGHEZZA LENGTH mm	COLORI COLORS
R 4172	110	125 pz / pcs	PVC	Standard 4000	* Standard RAL 9010 RAL 9002
R 4185	50	35 pz / pcs	PVC		
SB 1062	60	35 pz / pcs	PVC		
SB 8008	100	25 pz / pcs	PVC		
SB 8038	60	50 pz / pcs	PVC		

\*Su richiesta colori differenti/on demand different colours

### SUPPORTI IN ALLUMINIO / ALUMINIUM SUPPORT

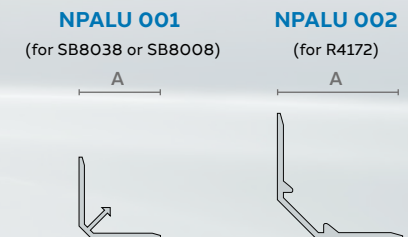

ARTICOLO ITEM	A mm	CONFEZIONI PACKAGING	MATERIALI MATERIALS	LUNGHEZZA LENGTH mm	COLORI COLORS
NPALU 001	30	250 pz / pcs	AL	Standard 4000	Alluminio Aluminium
NPALU 002	50	100 pz / pcs	AL		

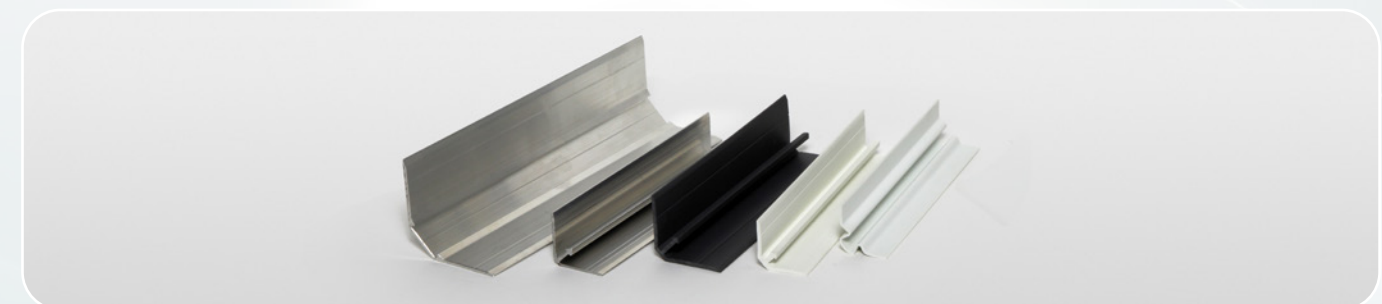



## RACCORDI / CORNER CAPS

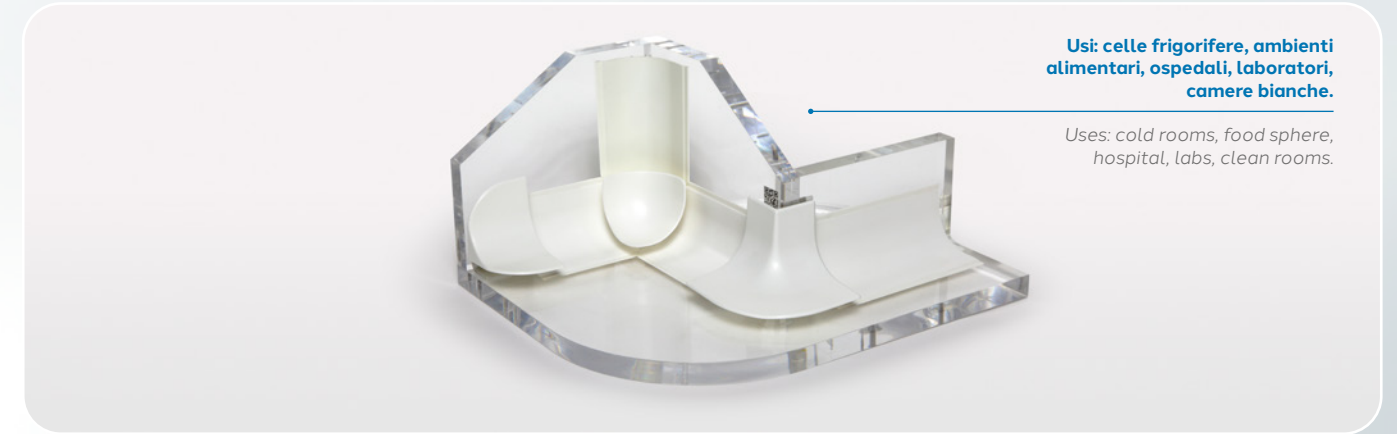

Usi: celle frigorifere, ambienti alimentari, ospedali, laboratori, camere bianche.

Uses: cold rooms, food sphere, hospital, labs, clean rooms.

NPR 030

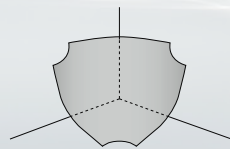
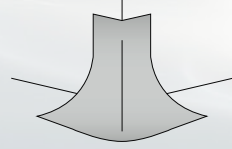
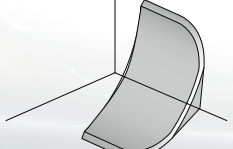
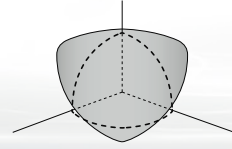
NPR 050 (for SB 8008)  
NPR 051 (for SB 8038)NPR 040 (for SB 8008)  
NPR 041 (for SB 8038)NPR 010 (for SB 8008)  
NPR 020 (for SB 8038)

ARTICOLO ITEM	DESCRIZIONE DESCRIPTION	CONFEZIONI PACKAGING	MATERIALI MATERIALS	COLORI COLORS
NPR 010	Raccordo angolo interno per/ Internal corner cap for: SB 8008	25 pz / pcs	PP	* Standard RAL 9010 RAL 9002
NPR 020	Raccordo angolo interno per/ Internal corner cap for: SB 8038	25 pz / pcs	PP	
NPR 030	Raccordo grande angolo interno per/ Big internal corner cap for: SB 8008	25 pz / pcs	PP	
NPR 040	Raccordo angolo laterale (DX,SX) per/ Lateral Corner cap (R,L) for: SB 8008	25 pz / pcs	PP	
NPR 041	Raccordo angolo laterale (DX,SX) per/ Lateral Corner cap (R,L) for: SB 8038	100 pz / pcs	PP	
NPR 050	Raccordo angolo esterno per/ External Corner cap for: SB 8008	25 pz / pcs	PP	
NPR 051	Raccordo angolo esterno per/ External Corner cap for: SB 8038	25 pz / pcs	PP	

\*Su richiesta colori differenti/ on demand different colours





## PROFILO BATTISCOPA SANITARIO ROUNDED PLINTH PROFILE

Indispensabili dove sia richiesta, oltre alla tradizionale funzione di battiscopa, una facile sanificazione ambientale e la garanzia delle norme igienico sanitarie vigenti. La messa in opera è veloce e definitiva e il profilo non presenta elementi di fissaggio a vista. Il sistema è dotato di accessori che completano la posa del profilo nelle diverse tipologie (angoli interni, esterni, supporti e terminali).

Essential where easy environmental sanitisation and respect for enforced hygienic standards are requested beside the traditional application as plinth profile. One-off and quick installation is guaranteed and the profile has no visible mounting elements. The system is equipped with accessories to complete any kind of mounting option (internal and external corner caps, mounting support and terminals).

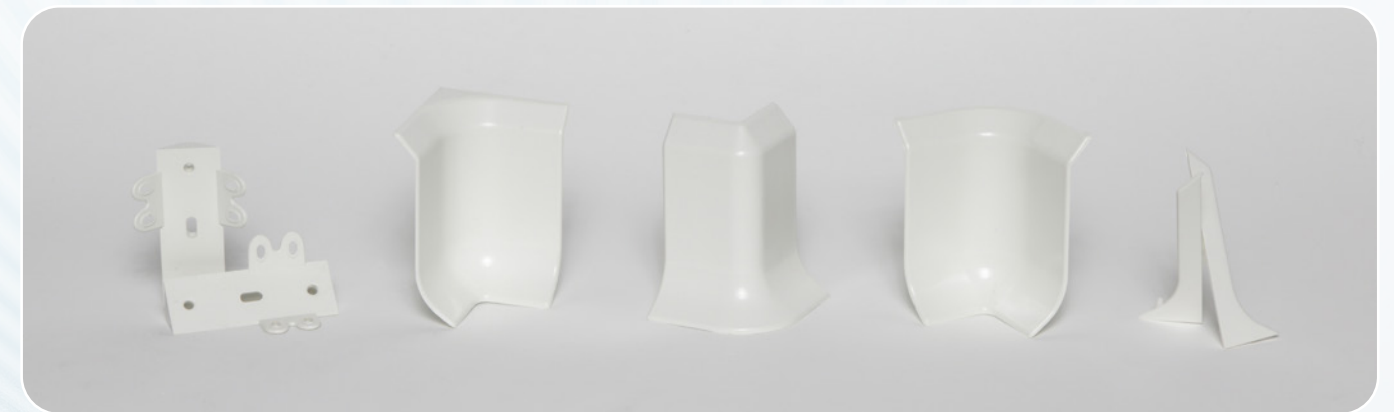

### RACCORDI / CORNER CAPS

NPR 003 SX

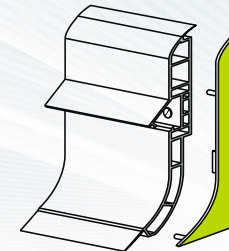

NPR 001

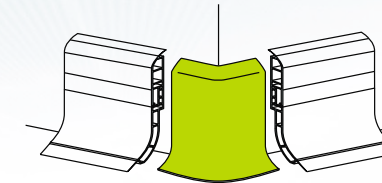

NPR 002 DX

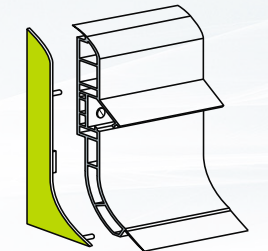

NPR 004

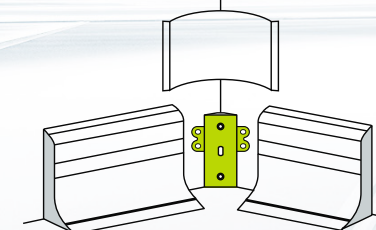

NPR 005

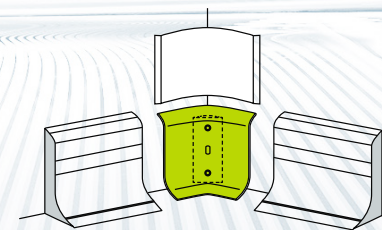

NPR 006

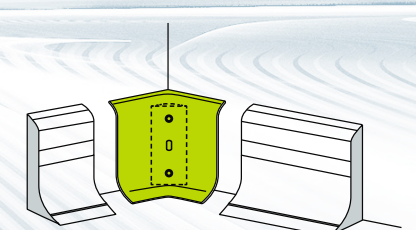

### PROFILO BATTISCOPA / PLINTH PROFILE

Usi: celle frigorifere, ambienti alimentari, ospedali, laboratori, camere bianche.

Uses: cold rooms, food areas, hospital, labs, clean rooms.

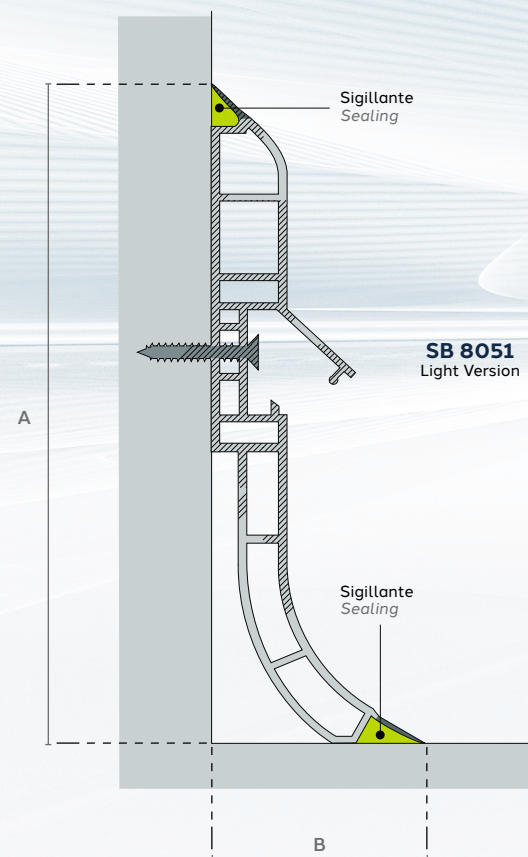
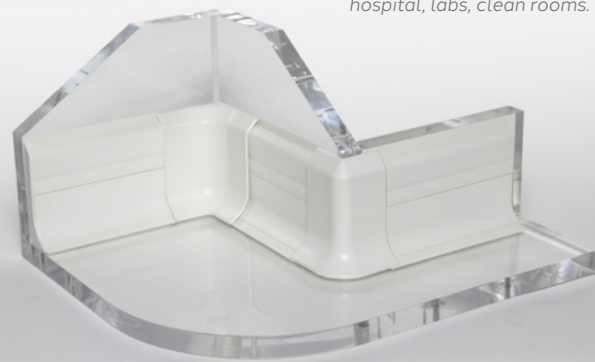

ARTICOLO ITEM	A mm	B mm	LUNGHEZZA LENGTH mm	CONFEZIONI PACKAGING	COLORI COLORS
SB 8051	95	30	4000	25 pz / pcs	* Standard RAL 9010 RAL 9002

\*Su richiesta colori differenti/on demand different colours

ARTICOLO ITEM	DESCRIZIONE DESCRIPTION	CONFEZIONI PACKAGING	COLORI COLORS
NPR 001	Raccordo angolo esterno/External corner cap	25 pz / pcs	* Standard RAL 9010 RAL 9002
NPR 002 DX	Copertura destra/Right cover	50 pz / pcs	
NPR 003 SX	Copertura sinistra/Left cover	50 pz / pcs	
NPR 004	Supporto per NPR 05-06//Bracket for NPR 05-06	50 pz / pcs	
NPR 005	Raccordo angolo interno 3 vie/Internal corner cap 3 ways	25 pz / pcs	
NPR 006	Raccordo angolo interno 2 vie/Internal corner cap 2 ways	25 pz / pcs	

\*Su richiesta colori differenti/on demand different colours



Si utilizzano nella costruzione di ambienti ad atmosfera controllata direttamente collocati su pavimenti esistenti.

Disponibili in tre versioni:

- semplice (MOD. A);
- con angolo sanitario dotato di ali morbide (MOD. C);
- con scanalature per una perfetta tenuta a pavimento e angoli arrotondati per un maggior livello sanitario (MOD. D).

Used in manufacture of prefab controlled temperature rooms directly based on existing floors.

Three versions are available:

- simple (MOD. A);
- with coving provided of soft edges (MOD. C);
- with grooves for a perfect floor-sealing and rounded corners for top sanitary level (MOD. D).

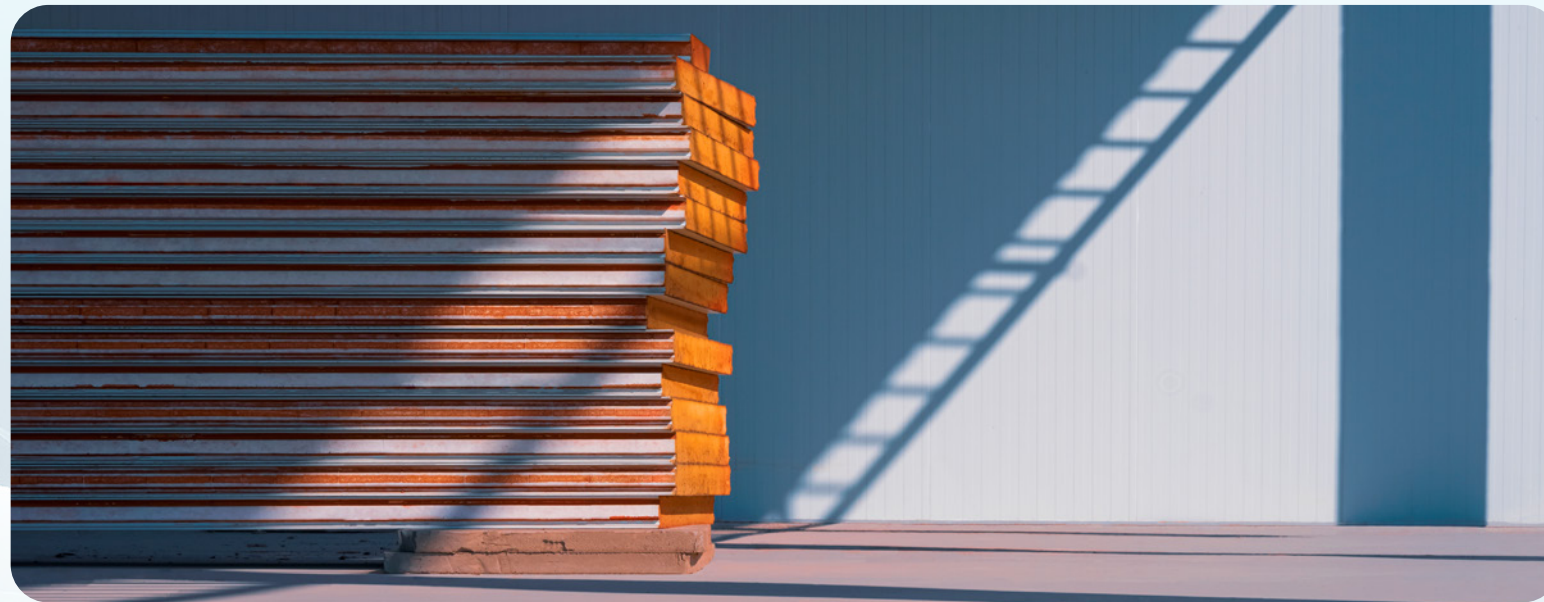

### MODELLO SEMPLICE/SIMPLE MODEL

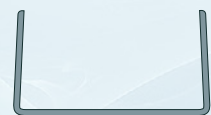
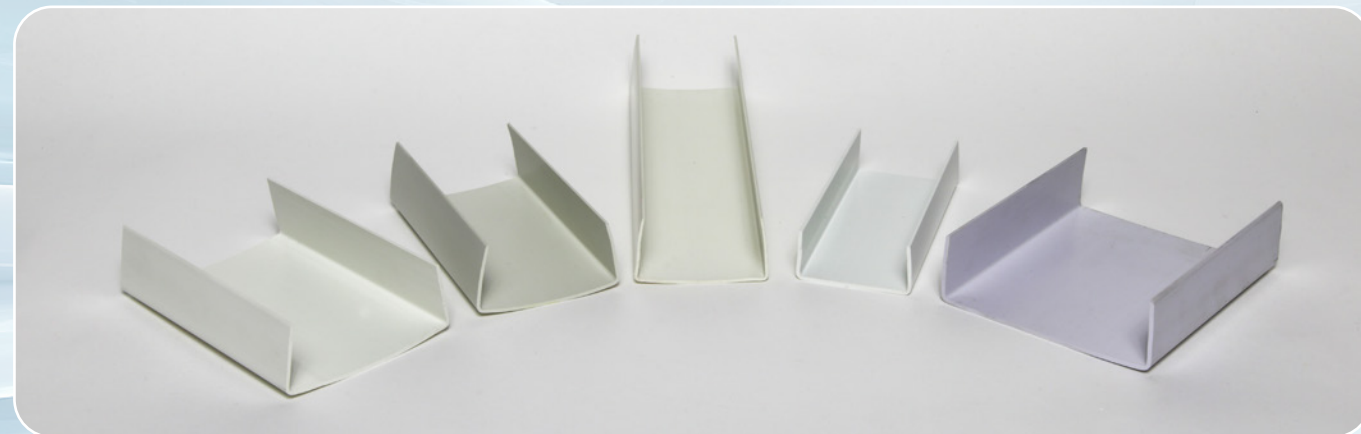

R 4171  
R 4124  
R 4125  
R 4126  
R 4127  
R 4128

ARTICOLO ITEM	PER PANNELLI DA MM FOR PANELS OF MM	A mm	LUNGHEZZA LENGTH mm	COLORI COLORS
R 4171	60	30	Standard 4000	Standard RAL 9010 RAL 9002
R 4124	70	40		
R 4125	80	40		
R 4126	100	40		
R 4127	110	40		
R 4128	120	40		

### MODELLO CON ANGOLO SANITARIO/MODEL WITH COVING

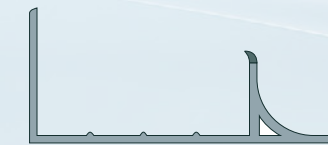
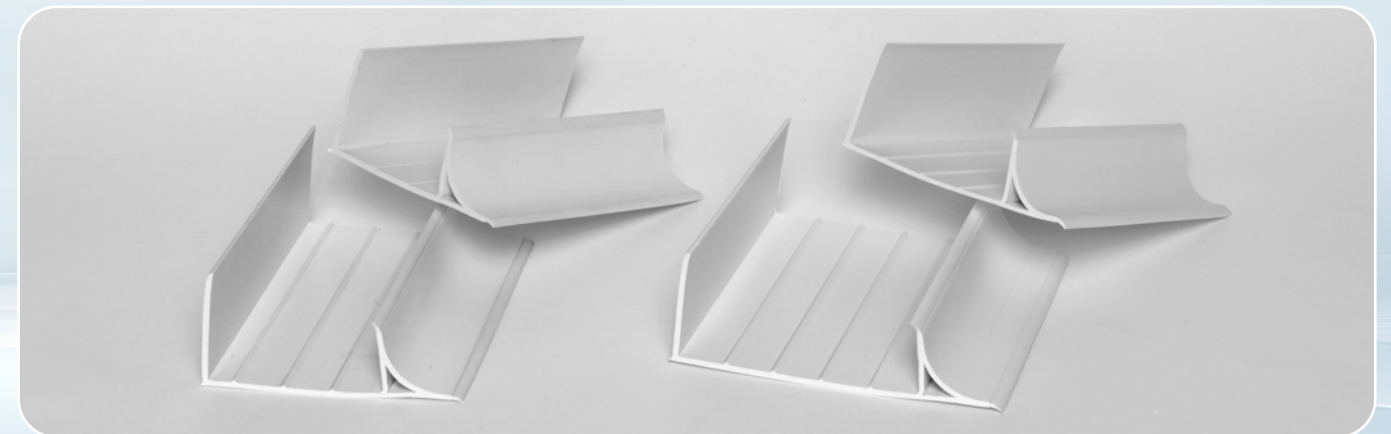

SB 8015  
SB 8028  
SB 8029  
SB 8016

ARTICOLO ITEM	PER PANNELLI DA MM FOR PANELS OF MM	A mm	LUNGHEZZA LENGTH mm	COLORI COLORS
SB 8015	60	36	Standard 4000	Standard RAL 9010 RAL 9002
SB 8028	70	36		
SB 8029	80	36		
SB 8016	100	36		



**MODELLO CON SCANALATURE E ANGOLI ARROTONDATI /  
MODEL WITH GROOVES AND ROUNDED CORNERS**

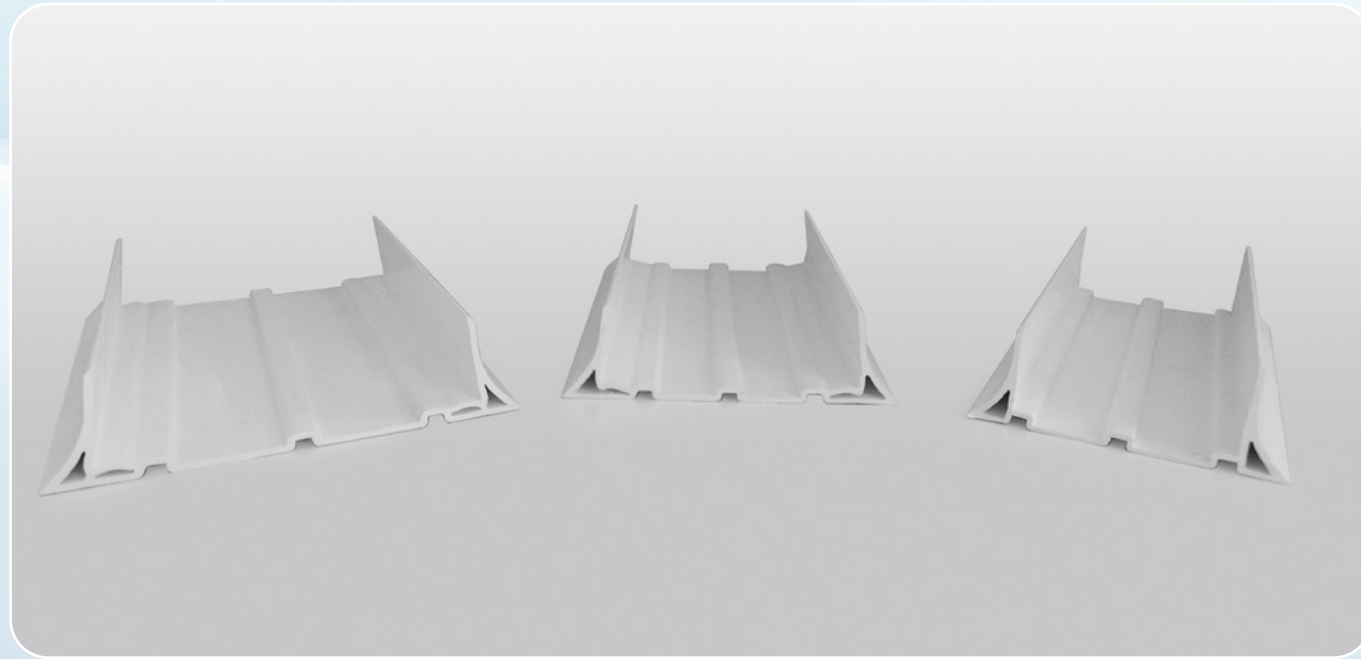

R 4217  
R 4193  
R 4194  
R 4195

ARTICOLO ITEM	PER PANNELLI DA MM FOR PANELS OF MM	A mm	LUNGHEZZA LENGTH mm	COLORI COLORS
R 4217	60	32	Standard 4000	Standard RAL 9010 RAL 9002
R 4193	70	32		
R 4194	80	32		
R 4195	100	32		

Usi: celle frigorifere, ambienti  
alimentari.

Uses: cold rooms, food areas.

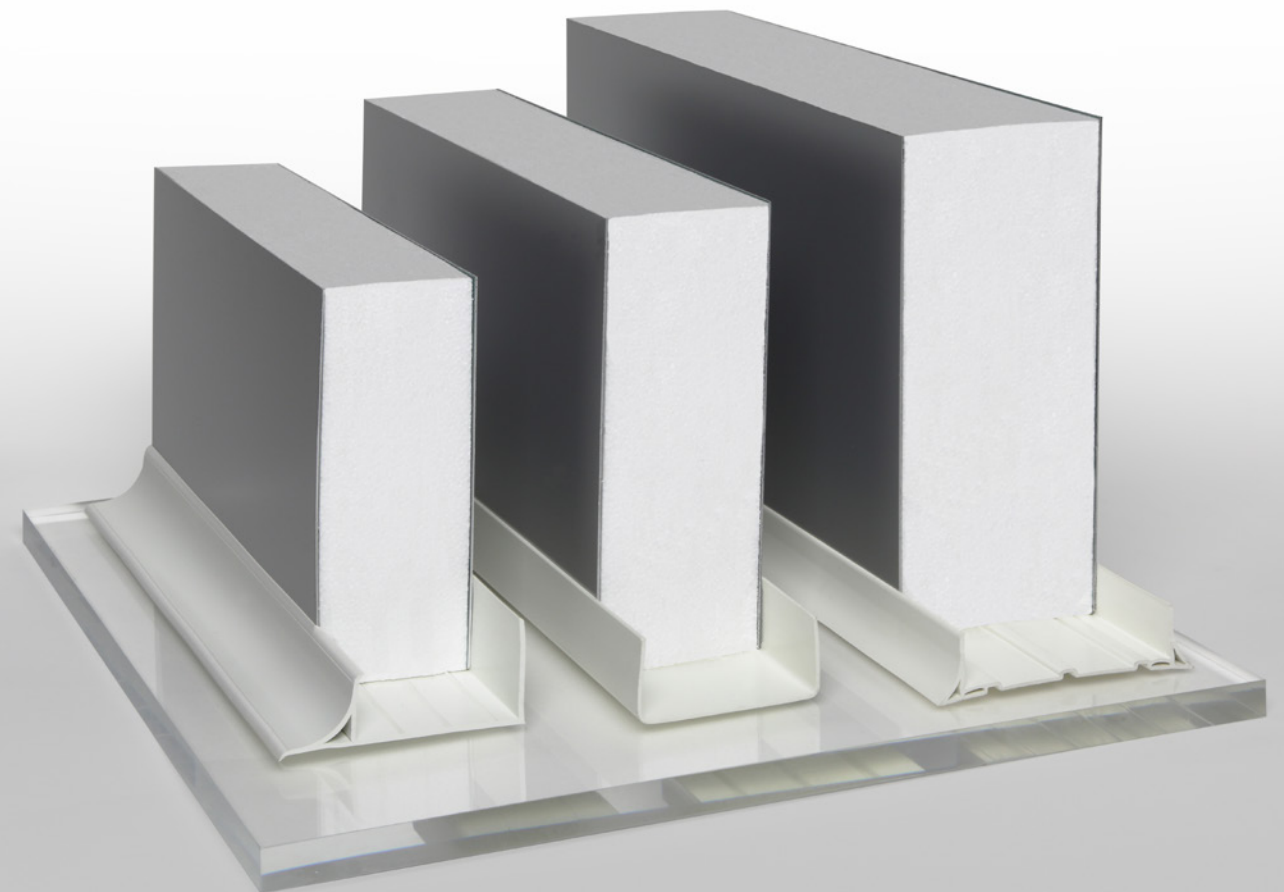



# PROFILI PORTAGUARNIZIONI

## STRIP-HOLDING PROFILES

Si adattano ai diversi stili di costruzione delle porte e contribuiscono ad evitare il ponte termico, prevenendo pericolosi punti di condensa. Le guarnizioni sono realizzate con materiali a base di gomma termoplastica espansa, resistenti fino alla temperatura minima di -40°C.

Suitable for different building styles of doors, they provide an important contribute to avoid the thermal head, saving from dangerous condense and frost formations. Gaskets are manufactured with foamed thermoplastic rubber, that can resist till -40°C.

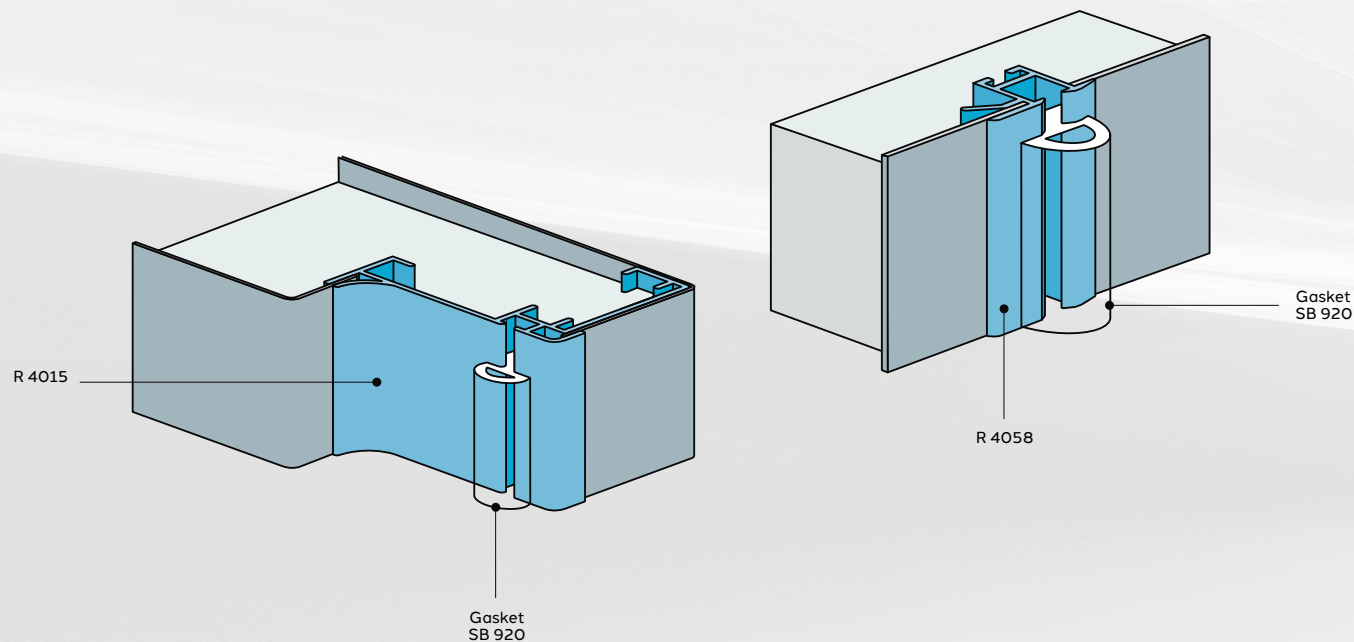

SB 920/SB 1065

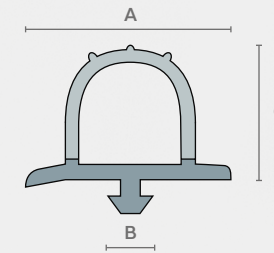

ARTICOLO ITEM	A mm	B mm	C mm	CONFEZIONE PACKAGING	COLORI COLORS
SB 920	28	5,8	20	Rotoli da 40 m/ Rolls of 40m	Standard White/Black
SB 1065	28	8	20	Rotoli da 40 m/ Rolls of 40m	

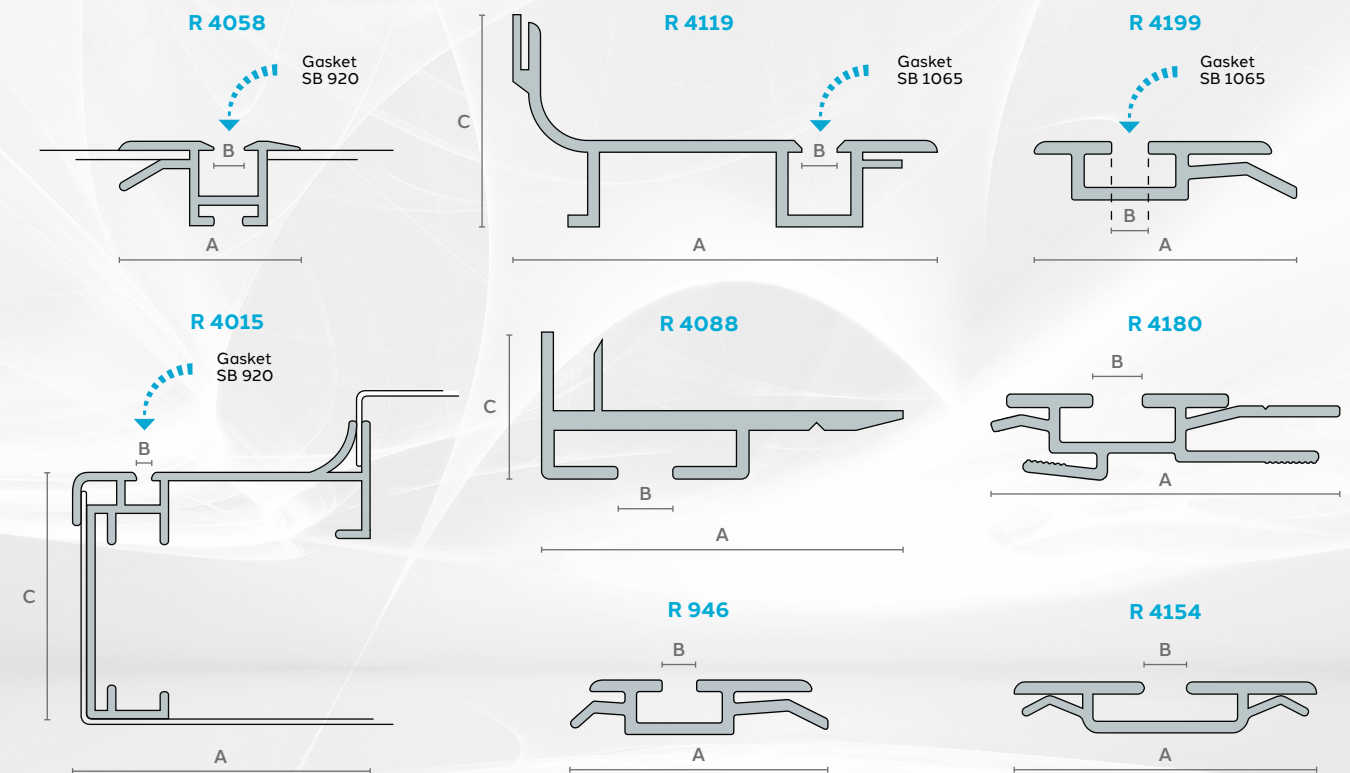

Usi: celle frigorifere, ambienti a temperatura controllata.  
Uses: cold rooms, controlled temperature rooms.

ARTICOLO ITEM	A mm	B mm	C mm	CONFEZIONE PACKAGING	LUNGHEZZA LENGTH mm	COLORI COLORS
R 946	33	4,4	-	50 pz/pcs	Standard 4000	Standard RAL 9010 RAL 9002
R 4015	57	3,5	48	10 pz/pcs		
R 4058	24	4	-	40 pz/pcs		
R 4088	46	9,5	18,7	25 pz/pcs		
R 4119	54	5	27	35 pz/pcs		
R 4154	41	6	-	25 pz/pcs		
R 4180	47	7	-	40 pz/pcs		
R 4199	28,5	4,4	-	50 pz/pcs		



Si utilizzano a completamento e finitura dei tradizionali pannelli coibentati nei vani porta. In ambienti refrigerati a basse temperature sono ideali i profili con apertura d'ispezione che permette di inserire e/o sostituire la resistenza elettrica necessaria a garantire il taglio termico.

Used to complete and finish traditional insulating panels on door frames. Profiles with inspection opening, that allows inserting and/or replacing electrical resistance and ensure the thermal break, are recommended in case of refrigerated areas.



R 4024  
R 4041  
R 4042  
R 4085

R 4040  
R 4043  
R 4168

Superficie microrigata  
Microgrooved surface

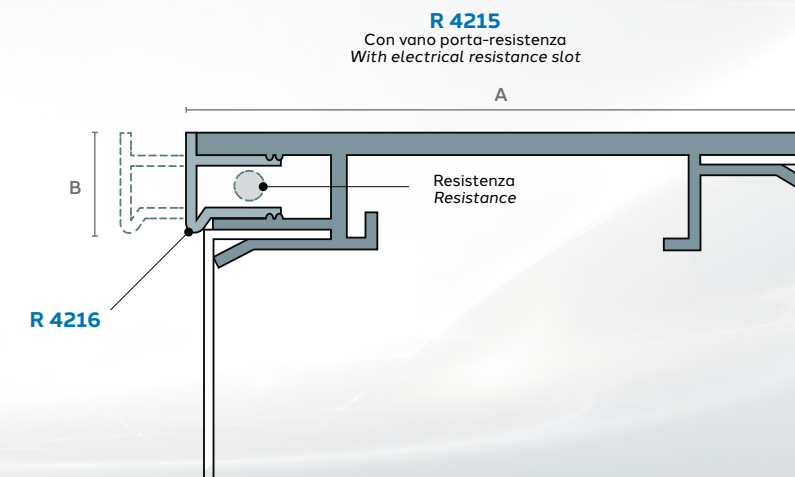
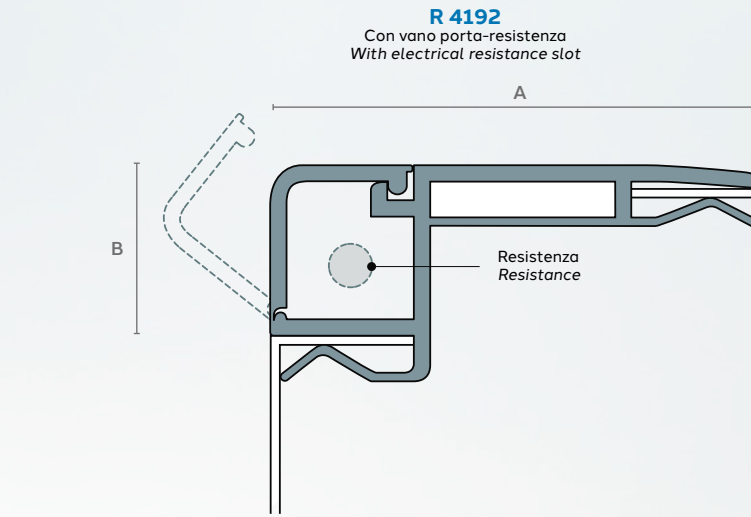
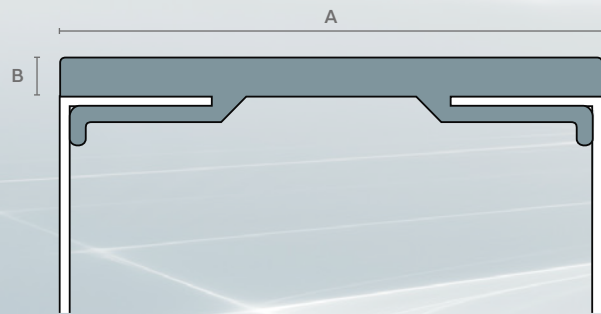
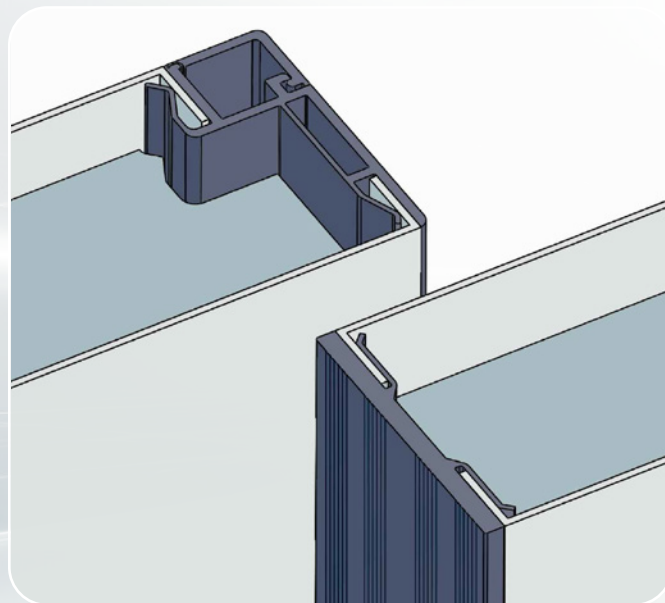

ARTICOLO ITEM	A mm	B mm	LUNGHEZZA LENGTH mm	COLORI COLORS
R 4192	60	20	Standard 4000	Standard RAL 9010 RAL 9002
R 4215/R 4216	80	13		

ARTICOLO ITEM	A mm	B mm	LUNGHEZZA LENGTH mm	COLORI COLORS
R 4024	30	1,5	Standard 4000	Standard RAL 9010 RAL 9002
R 4040	90	3		
R 4041	70	3		
R 4042 - R 4043	60	3		
R 4085	100	3		
R 4168	80	3		

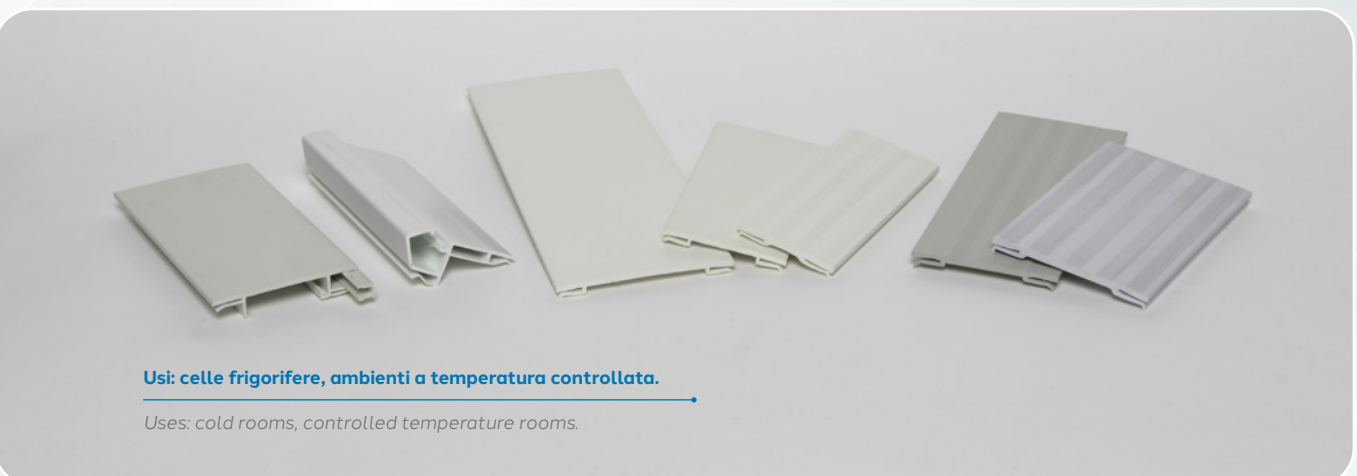

Usi: celle frigorifere, ambienti a temperatura controllata.

Uses: cold rooms, controlled temperature rooms.



Sono elementi componibili usati per la costruzione dei telai porte di ogni tipo: a battente e scorrevoli.

Questi telai sono adatti a porte di grandi dimensioni grazie alla robustezza dei suoi componenti.

Are modular system used in the frame construction of various doors: hinged doors, sliding and swing doors. These frames are suitable for big doors thanks to the thickness of their parts.



SISTEMA MODULARE  
MODULAR SYSTEM

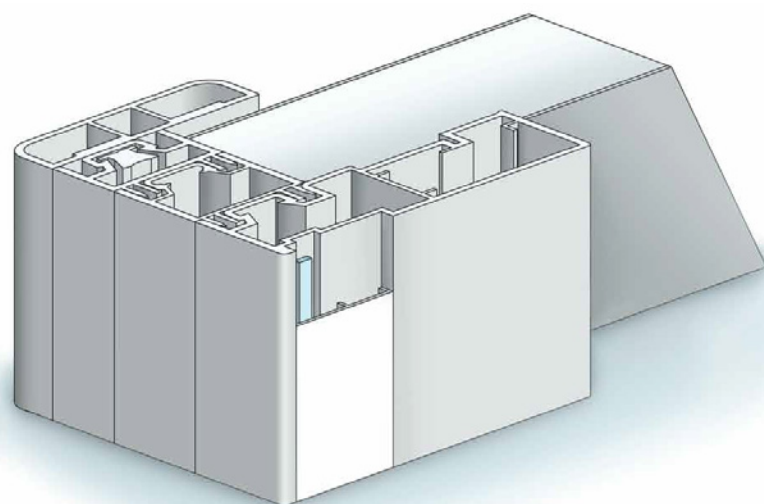
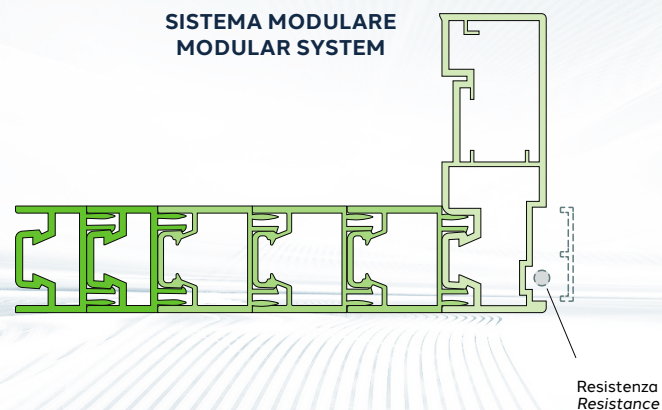

Usi: celle frigorifere, ambienti a temperatura controllata.

Uses: cold rooms, controlled temperature rooms.



R 4091

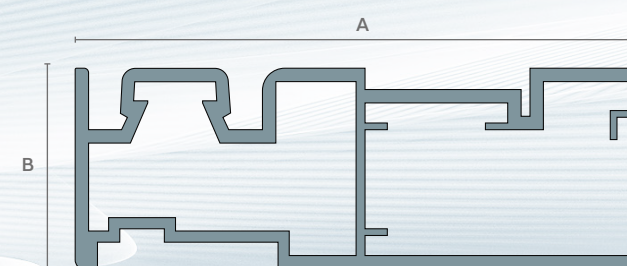

R 4092

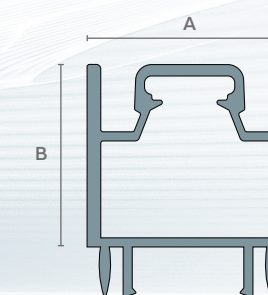

R 4093

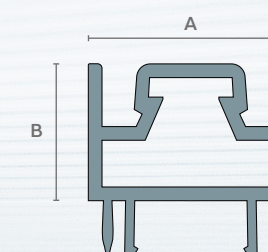

R 4094

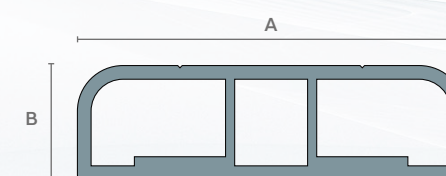

NPALU 003

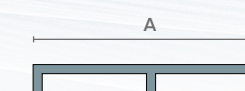

R 4165

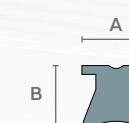

ARTICOLO ITEM	A mm	B mm	LUNGHEZZA LENGTH mm	COLORI COLORS
R 4091	129	45	Standard 4000	Standard RAL 9010 RAL 9002
R 4092	45	40		
R 4093	45	30		
R 4094	85	25		
R 4165	14,8	13		
NPALU 003	38	-		





R 4033  
R 4034  
R 4130  
R 4097  
R 4225  
R 4226  
R 4227

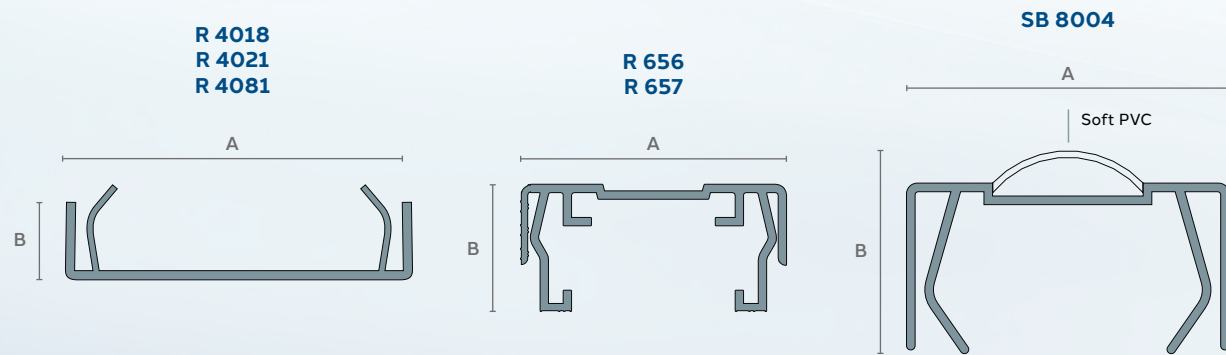
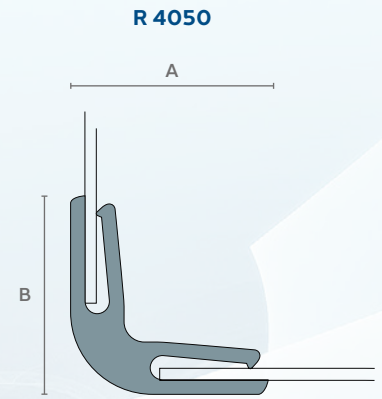
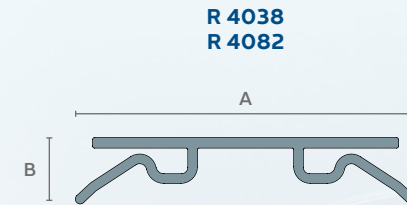
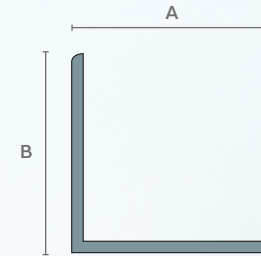

ARTICOLO ITEM	A mm	B mm	LUNGHEZZA LENGTH mm	COLORI COLORS
R 656	60	19	Standard 4000	Standard RAL 9010 RAL 9002
R 657	40	19		
R 4018	30	12		
R 4021	40	13		
R 4081	50	9		
SB 8004	30	19		



ARTICOLO ITEM	A mm	B mm	LUNGHEZZA LENGTH mm	COLORI COLORS
R 4033	20	20	Standard 4000	Standard RAL 9010 RAL 9002
R 4034	30	30		
R 4038	37	8		
R 4050	19	19		
R 4082	25	6		
R 4097	60	80		
R 4130	60	60		
R 4225	60	120		
R 4226	100	100		
R 4227	140	140		

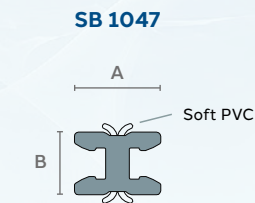
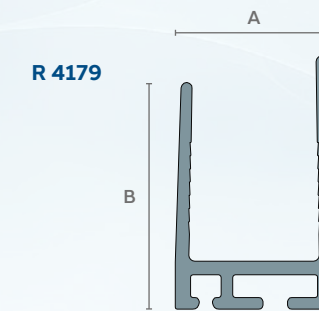

ARTICOLO ITEM	A mm	B mm	LUNGHEZZA LENGTH mm	COLORI COLORS
R 4179	24	34	Standard 4000	Standard RAL 9010 RAL 9002
SB 1047	13	9		



Viti e rondelle per  
telai porte, pannelli e soffitti.

Screw and washers for frames doors,  
panels and ceilings.



## VITI / SCREW

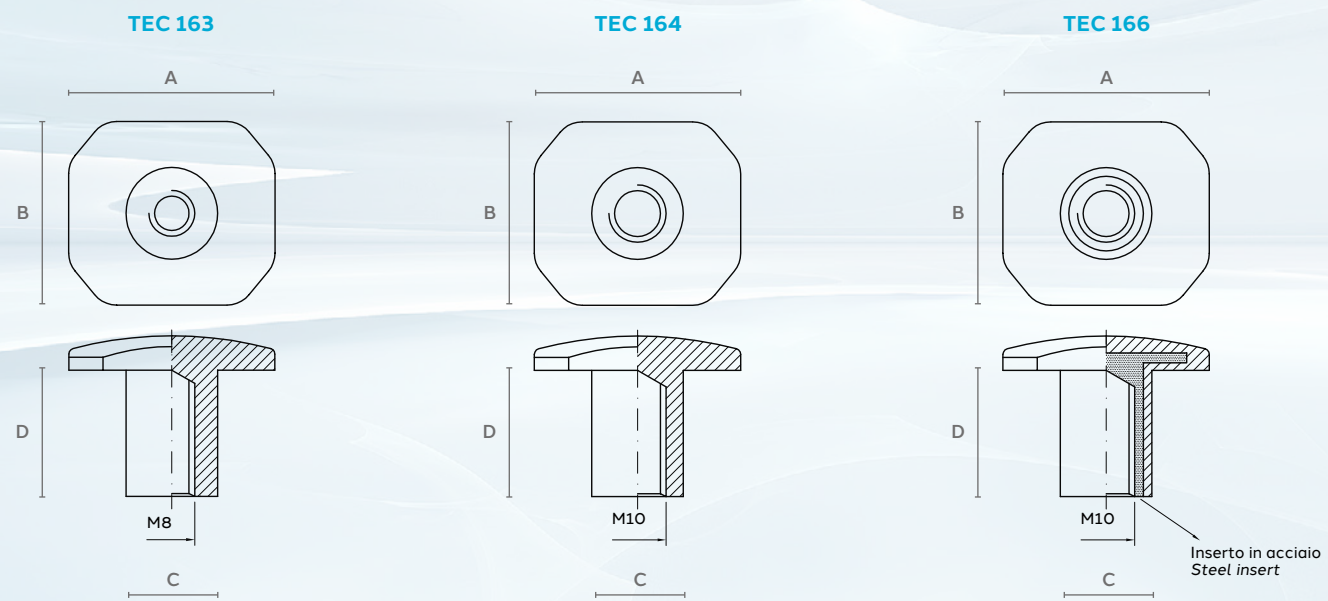

ARTICOLO ITEM	A mm	B mm	C mm	D mm	CONFEZIONE PACKAGING	COLORI COLORS
TEC 163	36	32	16	22	250 pz/pcs	Standard RAL 9010 RAL 9002
TEC 164	36	32	16	22	250 pz/pcs	
TEC 166	36	32	16	22	250 pz/pcs	

## RONDELLE / WASHERS

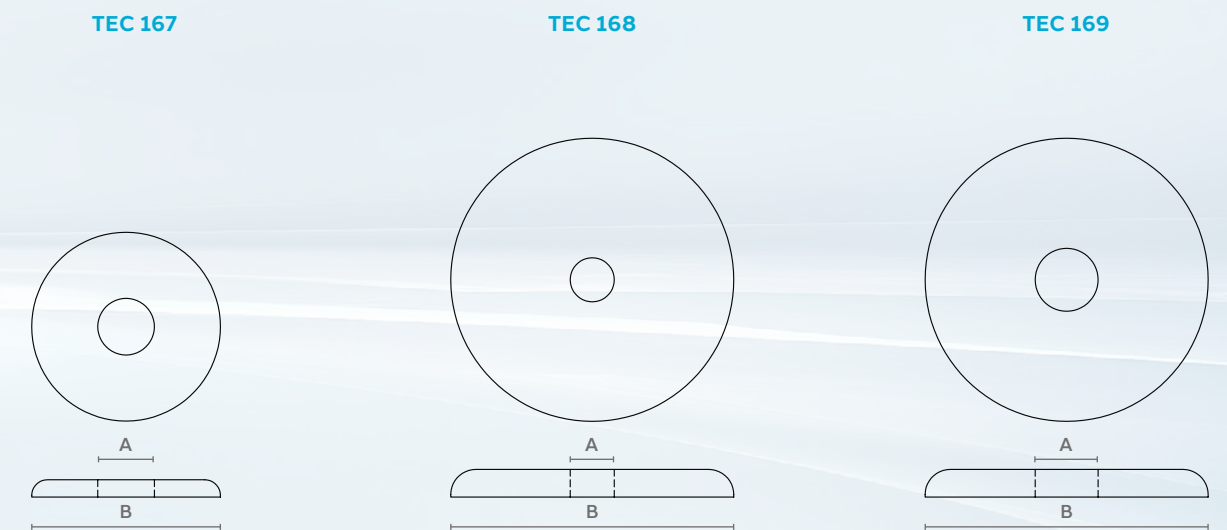

ARTICOLO ITEM	A mm	B mm	CONFEZIONE PACKAGING	COLORI COLORS
TEC 167	18	60	250 pz/pcs	Standard RAL 9010 RAL 9002
TEC 168	14	90	100 pz/pcs	
TEC 169	20	90	100 pz/pcs	



Sono usati come paracolpi e protezioni dove è richiesta pulizia e sicurezza.

Used as shock-absorbers and protections where cleanliness and safety are requested.

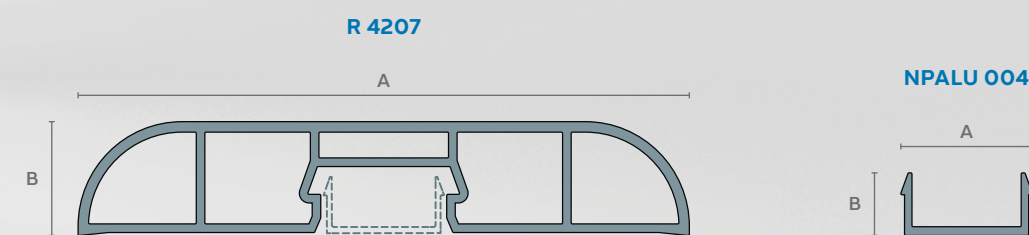
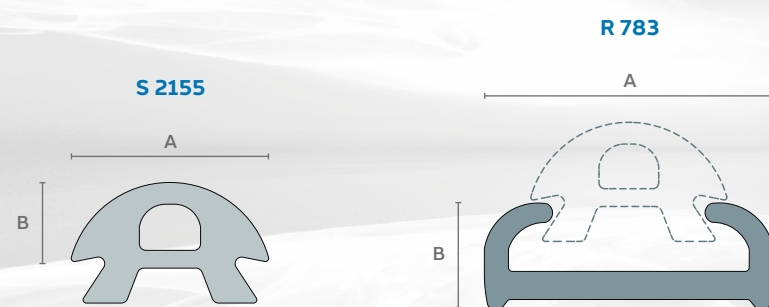

ARTICOLO ITEM	A mm	B mm	MATERIALI MATERIALS	LUNGHEZZA LENGTH mm	COLORI COLORS
S 2155	30	12	Soft PVC	Standard 4000	Standard RAL 9010 RAL 9002
R 783	36	13	PVC		
TEC 105	Chiusura per/End cap for: S 2155		PP		

ARTICOLO ITEM	A mm	B mm	MATERIALI MATERIALS	LUNGHEZZA LENGTH mm	COLORI COLORS
R 4207	100	18	PVC	Standard 4000	Standard RAL 9010 RAL 9002
NAPALU 004	20	10	Al		
TEC 103	Chiusura per/End cap for: R 4207		PP		
TEC 104	Raccordo angolo/Corner cap for: R 4207		PP		

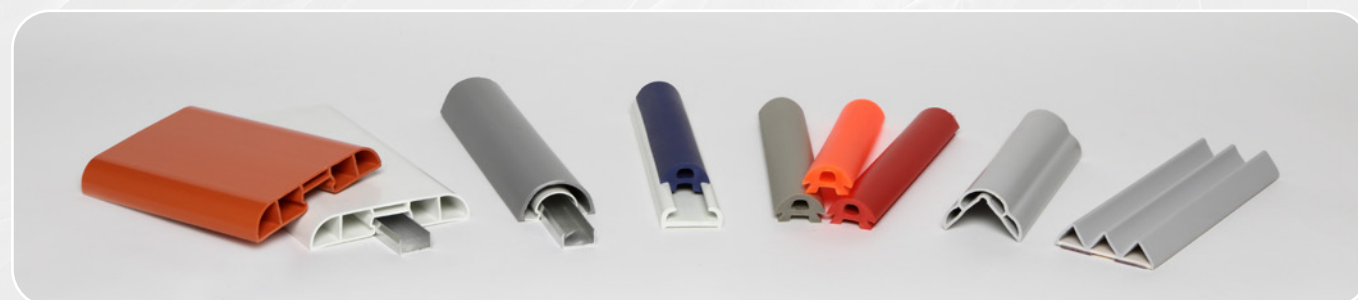



R 2169

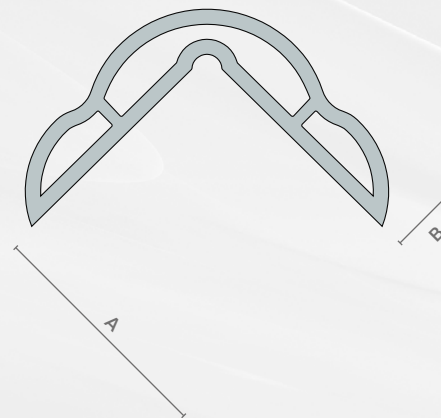

ARTICOLO ITEM	A mm	B mm	MATERIALI MATERIALS	LUNGHEZZA LENGTH mm	COLORI COLORS
S 2169	30	9	Soft PVC	Standard 4000	Standard RAL 9010 RAL 9002
TEC 170	Chiusura per/End cap for: S 2169		PP		

SB 1078

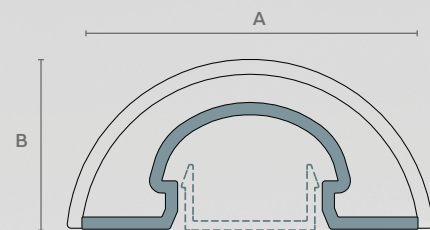

SB 1077

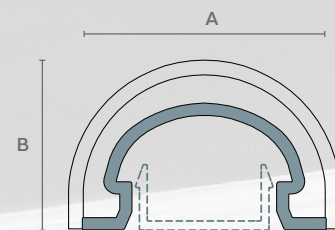

NPALU 004

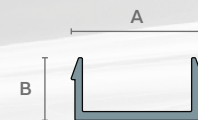

ARTICOLO ITEM	A mm	B mm	MATERIALI MATERIALS	LUNGHEZZA LENGTH mm	COLORI COLORS
SB 1077	38	23	Coextruded PVC	Standard 4000	Standard RAL 9010 RAL 9002
SB 1078	50	23	Coextruded PVC		
NAPALU 004	20	10	Al		
TEC 182	Chiusura per/End cap for: SB 1078		PP		
TEC 183	Raccordo angolo/Corner cap for: SB 1078		PP		
TEC 184	Chiusura per/End cap for: SB 1077		PP		
TEC 185	Raccordo angolo/Corner cap for: SB 1077		PP		

Usi: supermercati, ospedali, centri per l'infanzia,  
celle frigorifere, ambienti alimentari.

Uses: supermarkets, hospitals, childcare centers, cold  
rooms, food areas.







Usi: celle frigorifere, ambienti a temperatura controllata.

Uses: cold rooms, controlled temperature rooms.

TR 022



TR 020

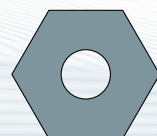

TR 019



TR 006



TR 034



TR 037



ARTICOLO ITEM	DIAMETRO mm DIAMETER mm	FORO mm HOLE mm	LUNGHEZZA mm LENGTH mm	COLORI COLORS
TR 006	8	4	Standard 4000	Standard RAL 9010 RAL 9002
TR 019	14	5		
TR 020	15	5		
TR 022	10	6		
TR 034	12	6		
TR 037	10	3		

R 849

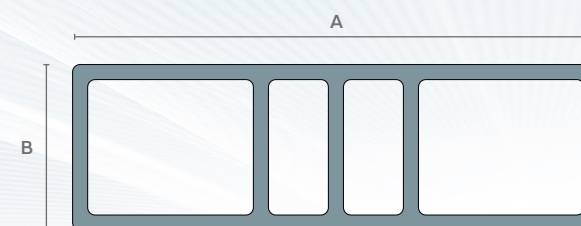

R 850

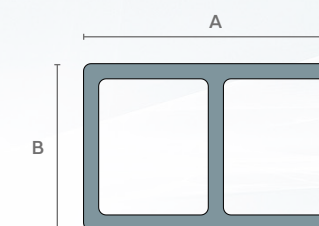

R 851

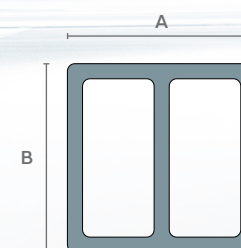

R 4098

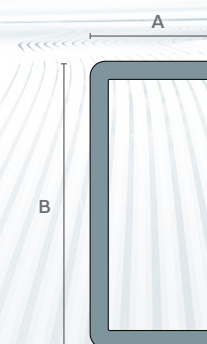

R 4155



ARTICOLO ITEM	A mm	B mm	LUNGHEZZA LENGTH mm	COLORI COLORS
R 849	70	22	Standard 4000	Standard RAL 9010 RAL 9002
R 850	35	22		
R 851	25	25		
R 4098	38	18		
R 4155	60	30		



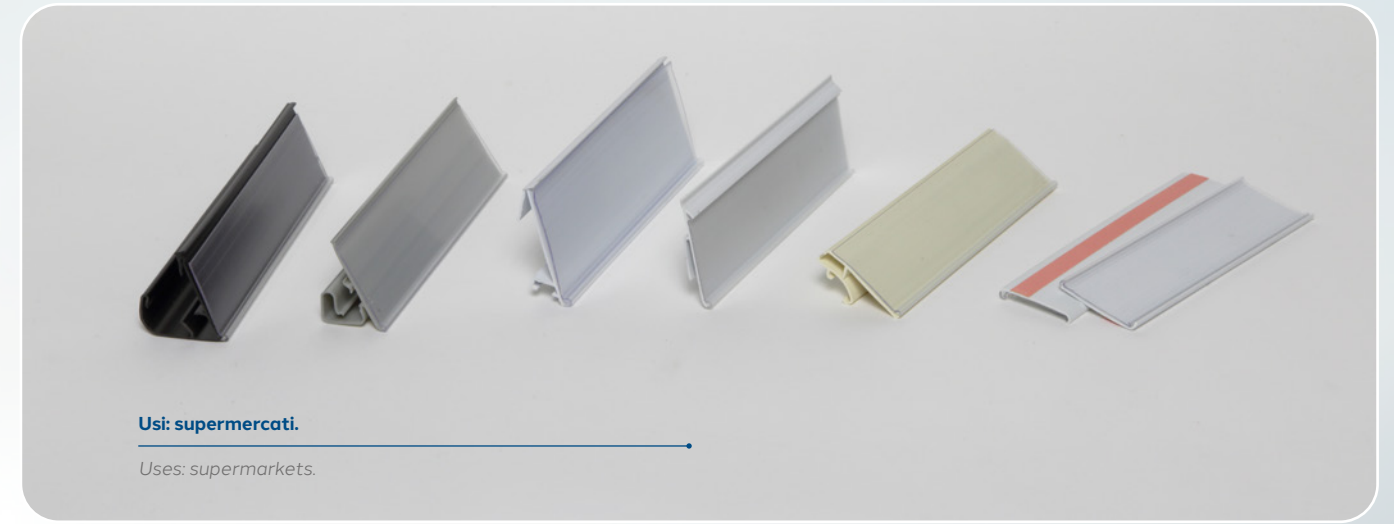

Usi: supermercati.

Uses: supermarkets.

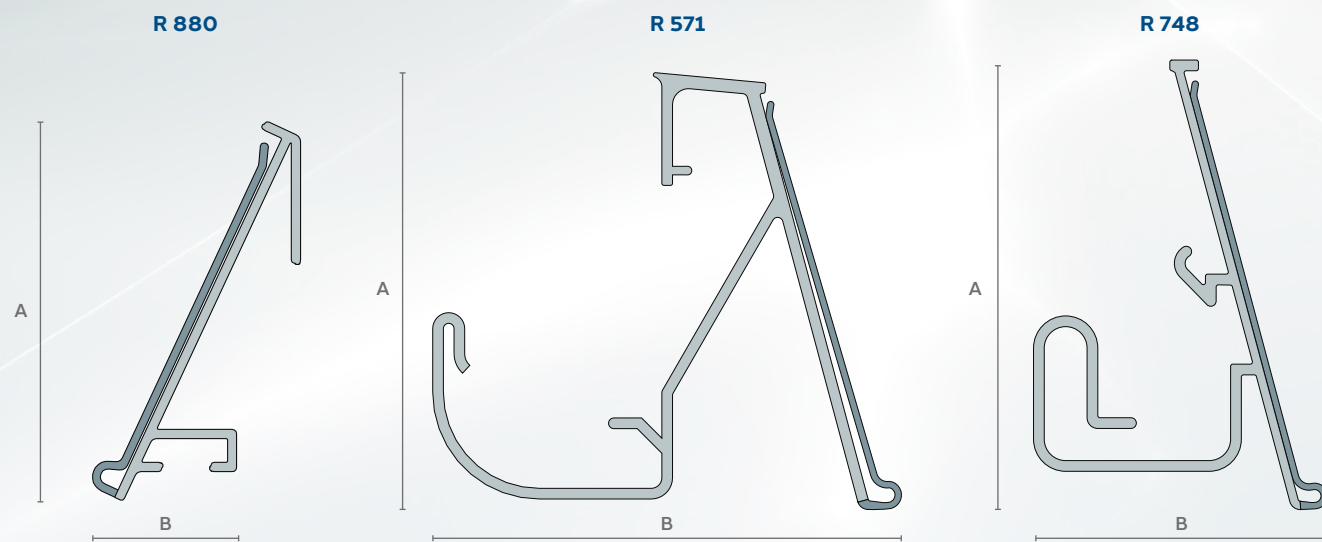
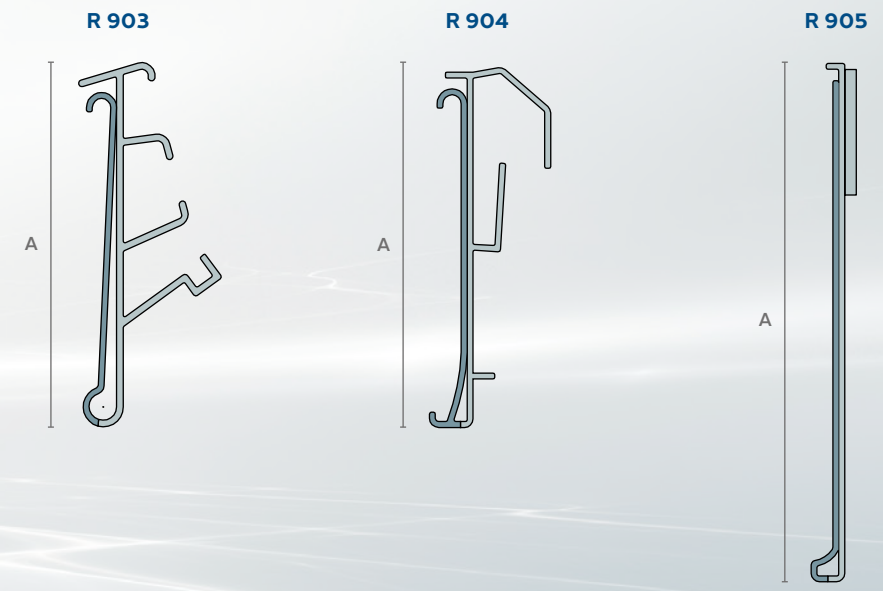
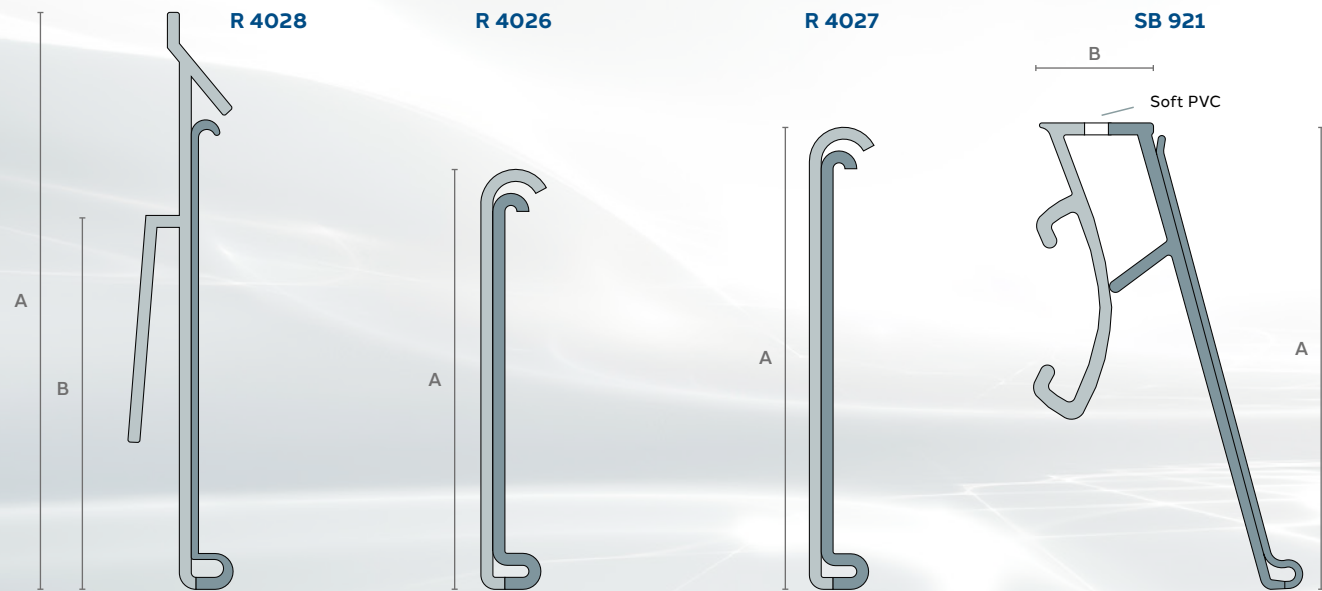

ARTICOLO ITEM	A mm	B mm	LUNGHEZZA LENGTH mm	COLORI COLORS
R 4028	40	30	A richiesta Custom	Standard RAL 9010 RAL 9002
R 4026	35	-		
R 4027	39	-		
SB 921	39	9,6		
R 571	41	44		
R 748	40	27		
R 880	50	-		
R 903	43,6	-		
R 904	43	-		
R 905	62	-		





Lombardini produce guarnizioni su richiesta del cliente, oltre a fornire profili standard.

Lombardini produces custom profiles, further to standard profiles.

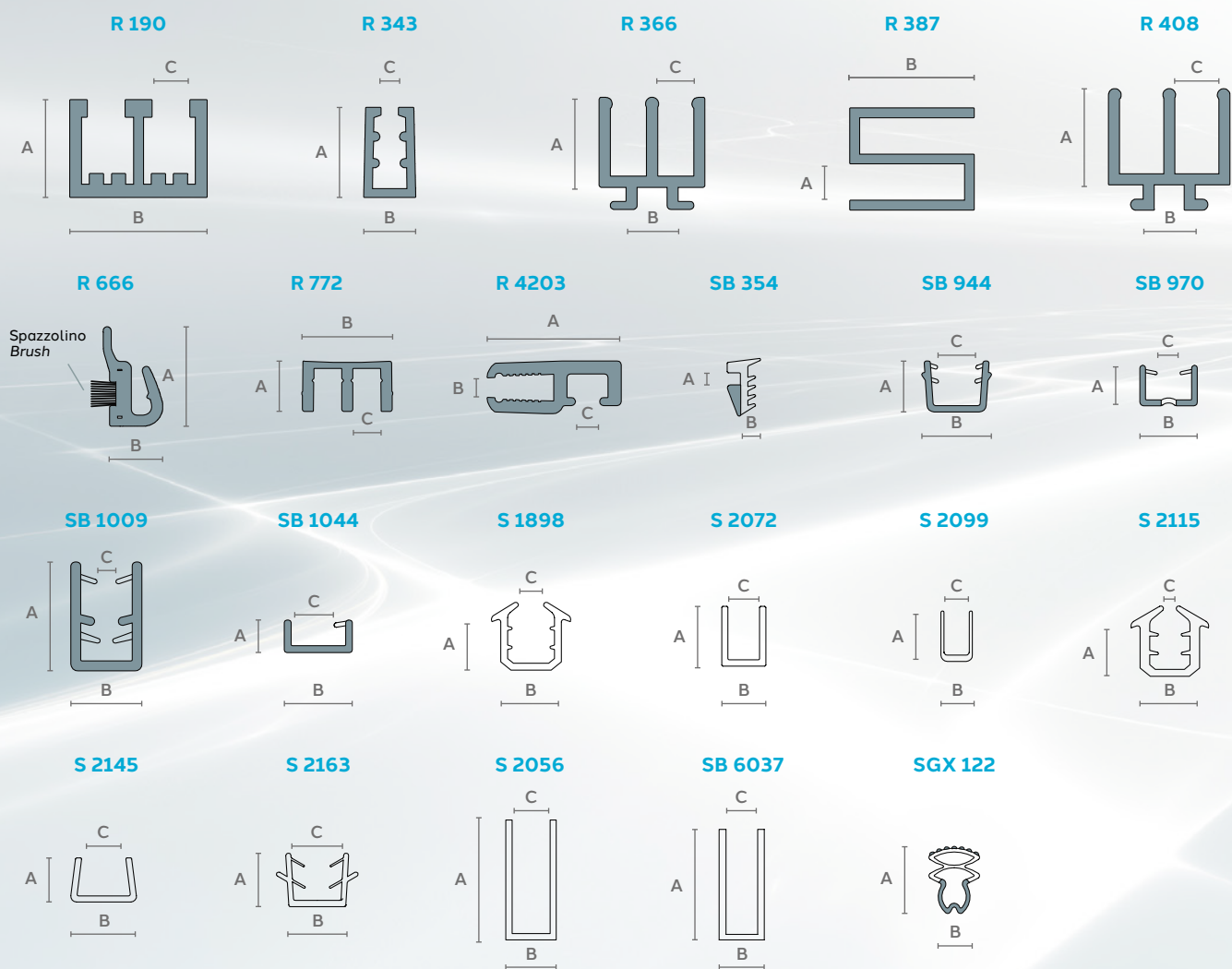

ARTICOLO ITEM	A mm	B mm	C mm	LUNGHEZZA LENGTH mm	COLORI COLORS
R 190	15,2	21,5	6	Standard 3000	Standard RAL 9010 RAL 9002
R 343	14	8	3		
R 366	14	8	6		
R 387	6	19,5	-		
R 408	15	8	6		
R 666	15,5	8,2	-		
R 772	7,7	14	4,75		
R 4203	21	3,4	4,1		
SB 354	2	2,4	-		
SB 944	7,8	9	5		
SB 970	6,3	9	3,6		
SB 1009	17	11	4		
SB 1044	4,9	10,5	6,9		
S 1898	8	9,6	6		
SR 2072	9,5	7	5		
S 2099	8	5	4		
S 2115	8	9,4	3,6		
S 2145	7	10,4	7		
S 2163	8,5	9	3,5		
S 2056	19	8	6		
S 6037	17,5	7,2	5		
SGX 122	10,5	5	-		





*Le immagini proposte in questo catalogo sono riproduzioni di profili estrusi che Lombardini Srl ha realizzato nel corso degli anni per i propri clienti e sono proposte puramente a fini esemplificativi.*

# COOLD SYSTEM

*The pictures in this catalogue are provided only as examples of some extruded profiles that Lombardini Srl manufactured along time for its clients.*





**Lombardini Srl**

Via Simone da Corbetta, 158 - 20011 Corbetta (MI) - Italy

Tel. +39 02 97 21 851 - [info@lombardinisrl.com](mailto:info@lombardinisrl.com)

[www.lombardinisrl.com](http://www.lombardinisrl.com)