

CUSTOM

Qualità ed esperienza fanno la differenza

Quality and experience make all the difference



LOMBARDINI
LOMBARDINI
LOMBARDINI
LOMBARDINI
LOMBARDINI
LOMBARDINI
LOMBARDINI
LOMBARDINI

THERMOPLASTIC EXTRUSION AND INJECTION MOULDING

CUSTOM

Sommario
Summary

1. Profili per serramenti
Profiles for doors and windows p. 04
2. Profili per sistemi di arredo
Profiles for furniture p. 06
3. Profili per trattamento aria e acqua
Profiles for air and water handling p. 08
4. Profili per applicazioni industriali
Profiles for industrial applications p. 10
5. Profili per edilizia
Profiles for building industry p. 12
6. Profili per nautica
Profiles for boat p. 16
7. Profili per la grande distribuzione
Profiles for supermarkets p. 18
8. Profili per rivestimenti e controsoffitti
Profiles for wall and false ceilings p. 22



Lombardini srl è in grado di realizzare profili monoestrusi, coestrusi, triestrusi e stampati. Le tipologie di materiali lavorati sono: PVC, PVC ESPANSO, ABS, PP, PS, PMMA, PC, TPE, SBS, SEBS, PE, PEHD. L'esperienza maturata in oltre sessant'anni di attività nel settore di estrusione e stampaggio di materie plastiche e la continua ricerca di nuove tecnologie, hanno permesso a Lombardini di crescere fino a diventare un punto di riferimento per il mercato. Dal 1955 ad oggi ha creato più di 4.000 sagome, estrudendo più di 250 milioni di metri di profili.

La trasformazione delle materie plastiche inizia con la progettazione personalizzata, prosegue con la costruzione interna delle attrezzature, fino ad arrivare al prodotto commissionato.

Gli esperti sono a disposizione per una consulenza competente e professionale, in grado di soddisfare anche i clienti più esigenti.

Tutto il processo produttivo è certificato ISO 9001-2015.

Lombardini srl is able to produce mono-extruded, co-extruded, tri-extruded and moulded profiles. The types of materials processed are: PVC, EXPANDED PVC, ABS, PP, PS, PMMA, PC, TPE, SBS, SEBS, PE, PEHD. The experience acquired over more than sixty years in the plastic extrusion and moulding sector and the continuous research into new technologies have enabled Lombardini to grow and become a major player in the market. Since 1955, we have created more than 4,000 shapes, extruding more than 250 million metres of profiles.

Transformation of plastics starts with the customised design, followed by the in-house manufacture of the tools, and ending with the commissioned product.

Experts are on hand to provide competent and professional advice that will satisfy even the most discerning of customers.

The entire production process is ISO 9001-2015 certified.



Assistenza / Assistance

Assistenza a 360° del cliente. L'ufficio tecnico interpreta le richieste del cliente, studia la fattibilità, suggerisce eventuali modifiche e realizza il disegno esecutivo. Lombardini offre inoltre **assistenza completa** anche nel post-vendita.
*360° customer assistance. The technical office interprets the client's requests, studies the feasibility, suggests possible modifications and realizes the executive design. Lombardini also offers **complete assistance** even in the after-sales service.*



Esperienza / Experience

L'esperienza maturata in oltre sessant'anni di attività nel settore di estrusione e stampaggio di materie plastiche e la continua ricerca di **nuove tecnologie**, hanno permesso alla Lombardini di crescere fino a diventare un punto di riferimento in grado di interpretare alla perfezione ogni tipo di esigenza.
*The experience gained in more than sixty years of work in the field of plastics extrusion and moulding, and the continuous research of **new technologies**, have allowed Lombardini to grow until to become a benchmark able to meet every requirement at all.*



100% personalizzazione / 100% customized

Lombardini è in grado di realizzare autonomamente attrezzature e calibri di raffreddamento grazie all'officina meccanica interna, ottimizzando i costi e le tempistiche di costruzione. La flessibilità e la disponibilità dei tecnici e la capacità di dare vita in tempi brevi a **qualsunque tipo di progetto** professionale è il fiore all'occhiello dell'azienda.
*Lombardini is able by itself of achieving tools and cooling calibrations through internal mechanical workshop, by a cost optimization and working timing. The staff's flexibility and availability and its ability to create shortly **any kind of professional project** is the company's flagship.*



Qualità / Quality

Tecnologia, disponibilità ed elevato standard qualitativo sono i tratti distintivi della Lombardini. Tutti i prodotti sono completamente **Made in Italy**, realizzati utilizzando materiali di prima qualità. Tali caratteristiche, insieme alla certificazione ISO 9001:2015 rendono l'azienda affidabile ed una garanzia da tutti i punti di vista.
*Technology, availability and high-quality standards are the Lombardini hallmarks. All products are completely **made in Italy**, realized by top quality materials. These characteristics, with the ISO 9001:2015 certification, make the company trustworthy and a guarantee in all respects.*

Alcuni esempi dei nostri prodotti / Some examples of our products

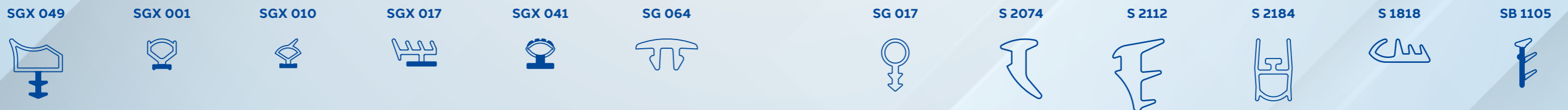
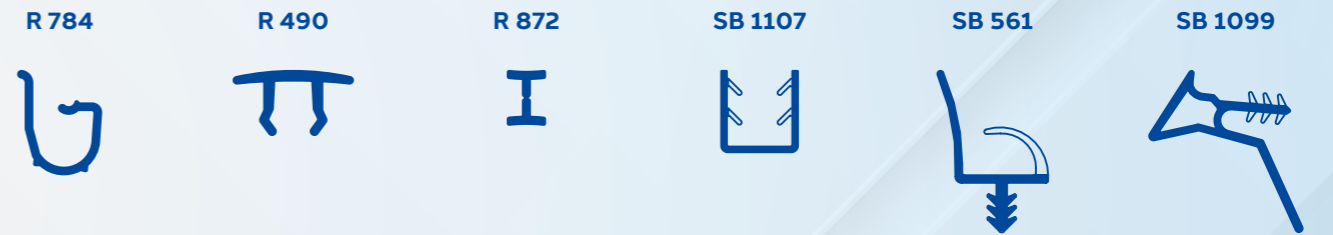
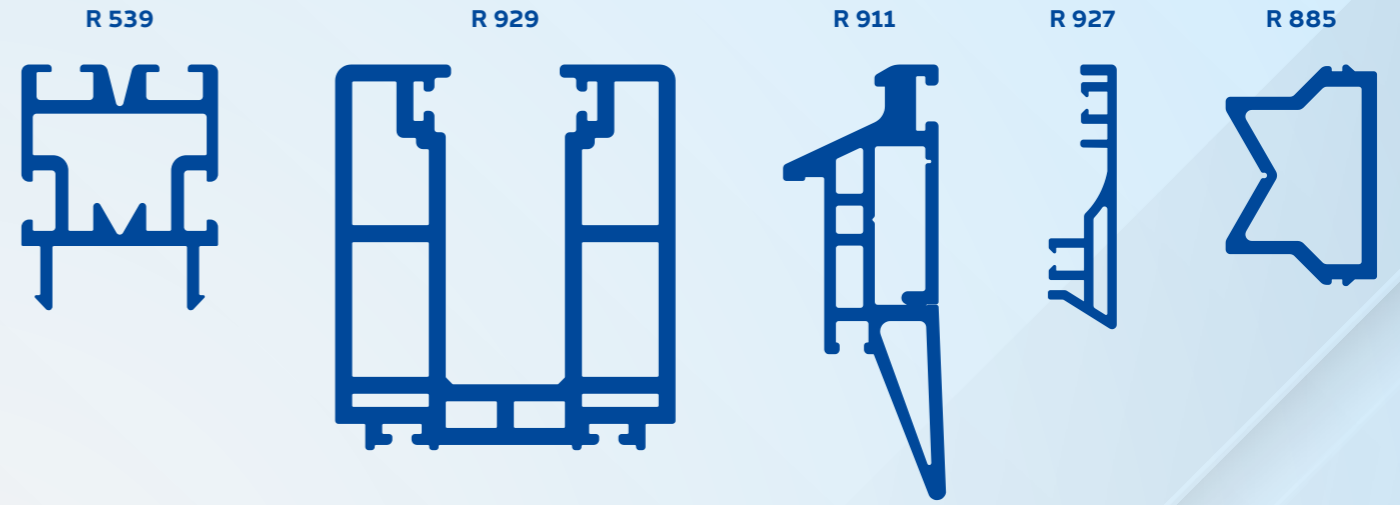

SCALA 1:1 - 1:1 SCALE

□ Flessibile - Flexible ■ Rigido - Rigid

Alcuni esempi dei nostri prodotti / Some examples of our products

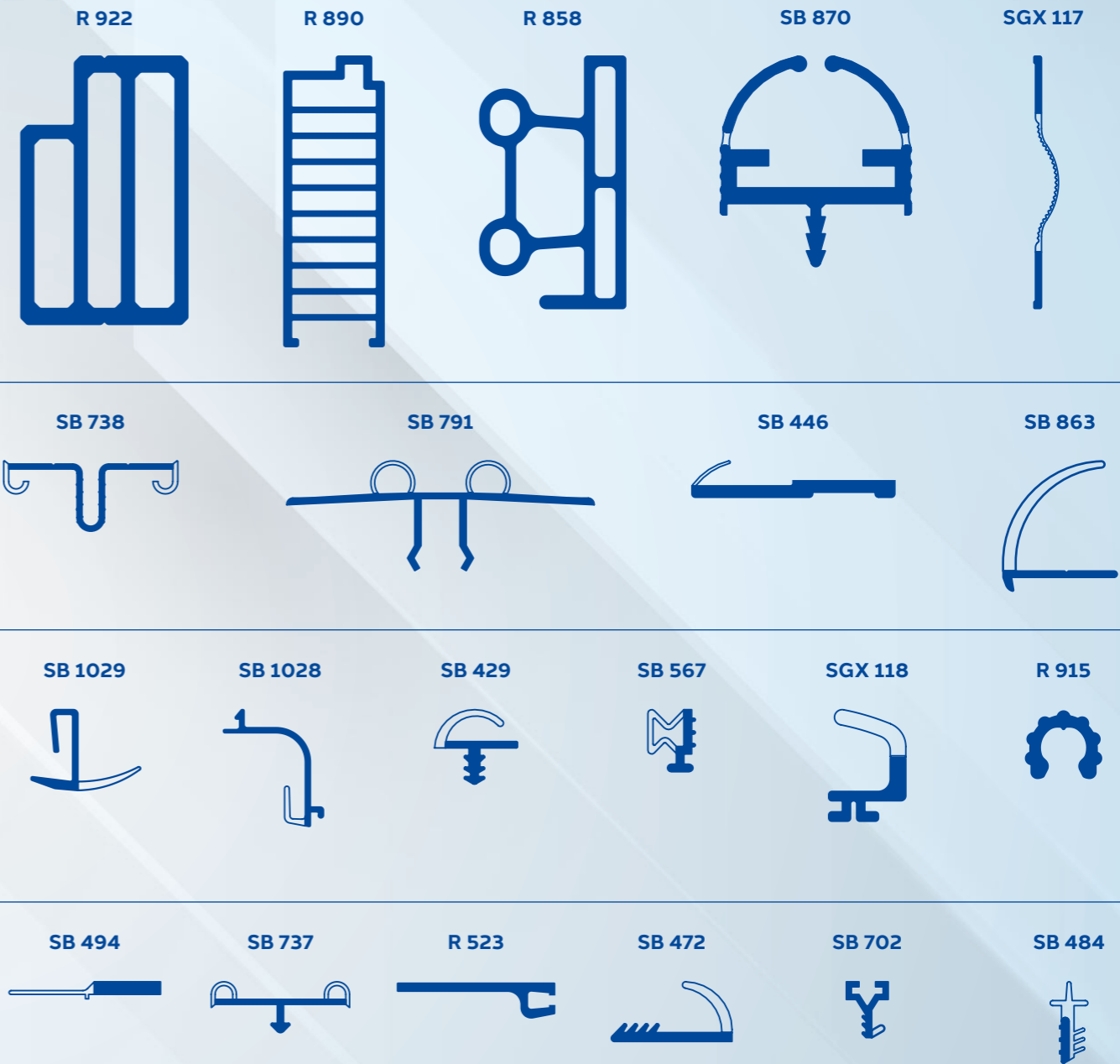

SCALA 1:1 - 1:1 SCALE

□ Flessibile - Flexible ■ Rigido - Rigid

Alcuni esempi dei nostri prodotti / Some examples of our products



R 4179



SB 1047



LEO 600

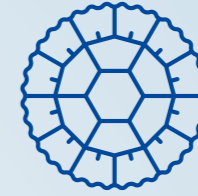

R 896



R 598



R 935



SCALA 1:1 - 1:1 SCALE

 Flessibile - Flexible  Rigido - Rigid

Alcuni esempi dei nostri prodotti / Some examples of our products

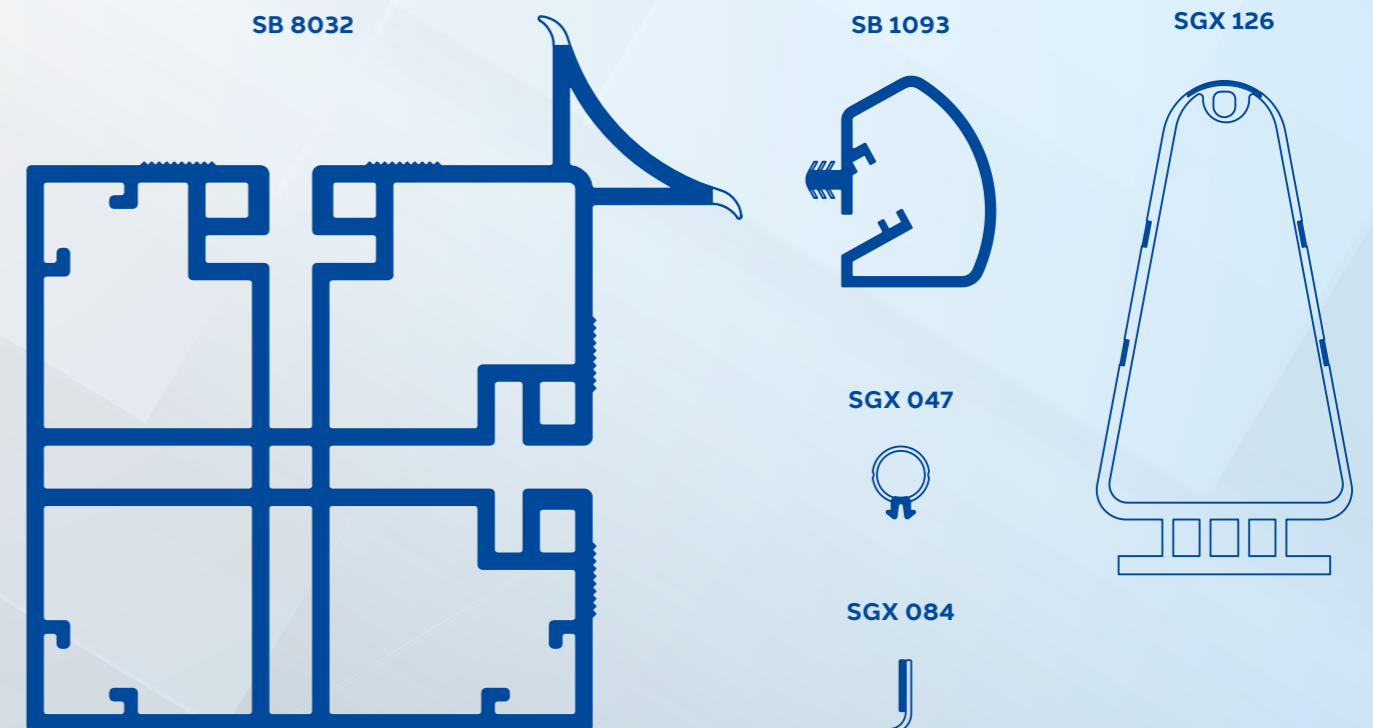
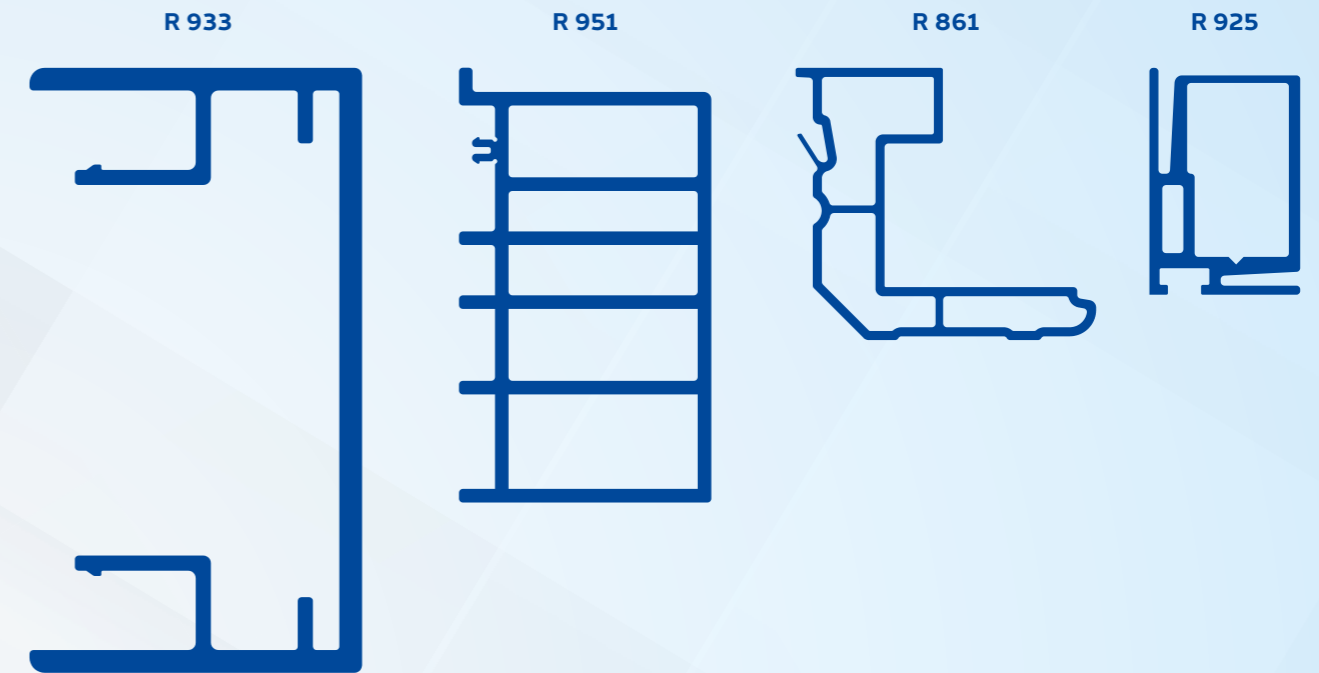

SCALA 1:1 - 1:1 SCALE

□ Flessibile - Flexible ■ Rigido - Rigid

Alcuni esempi dei nostri prodotti / Some examples of our products



R 242



R 901



R 4169



R 899



R 809



R 829



SB 1088

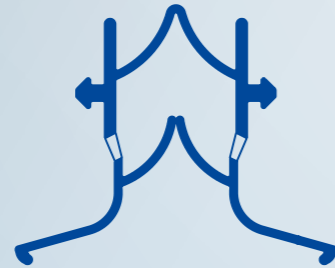

R 849



R 892



SCALA 1:1 - 1:1 SCALE

 Flessibile - Flexible  Rigido - Rigid

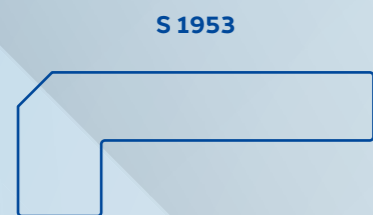

S 1953



S 1503

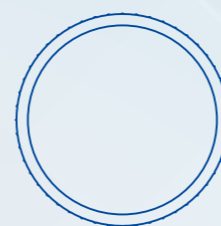

TF 120



TR 009



TR 019

∅ (ext.) 14



TR 022

∅ (ext.) 10



TR 037

∅ (ext.) 10



S 1175

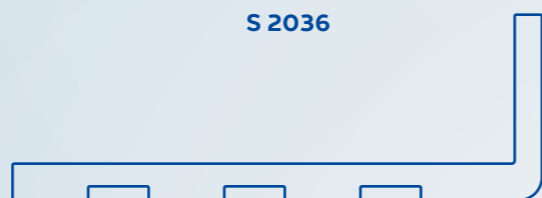

S 2036

∅ (ext.) 28

∅ (ext.) 31,4

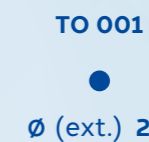

TO 001

∅ (ext.) 2,5



TF 053

∅ (ext.) 8

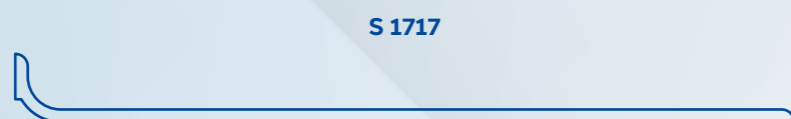

S 1717



SB 8008



R 4170

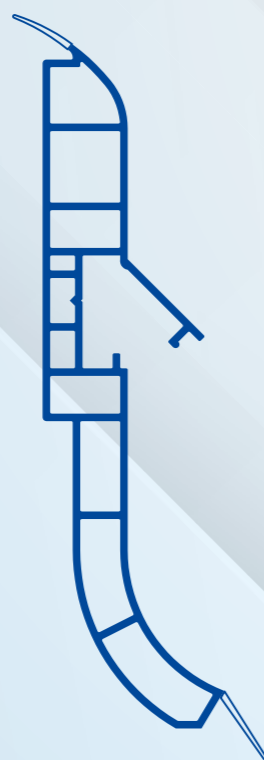

SB 8051



SB 1006



SB 1016



SB 972



SCALA 1:1 - 1:1 SCALE

 Flessibile - Flexible  Rigido - Rigid

Alcuni esempi dei nostri prodotti / Some examples of our products

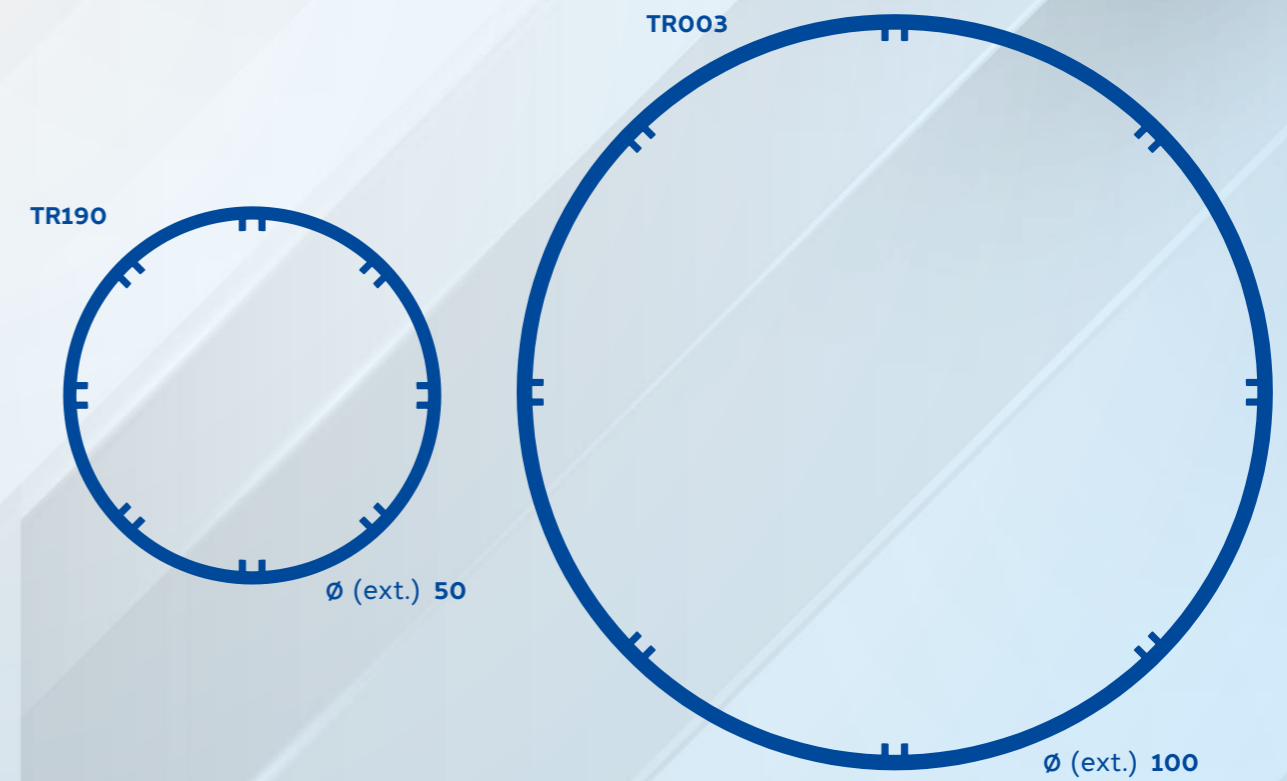
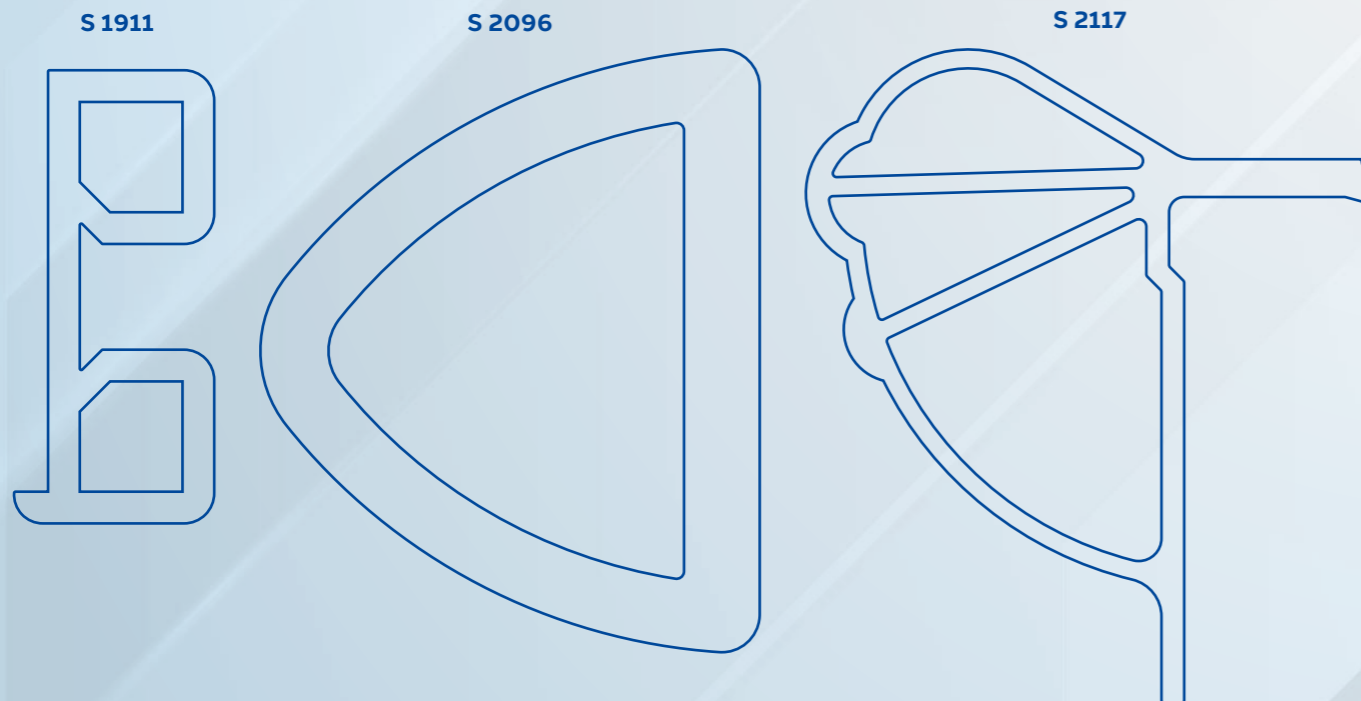
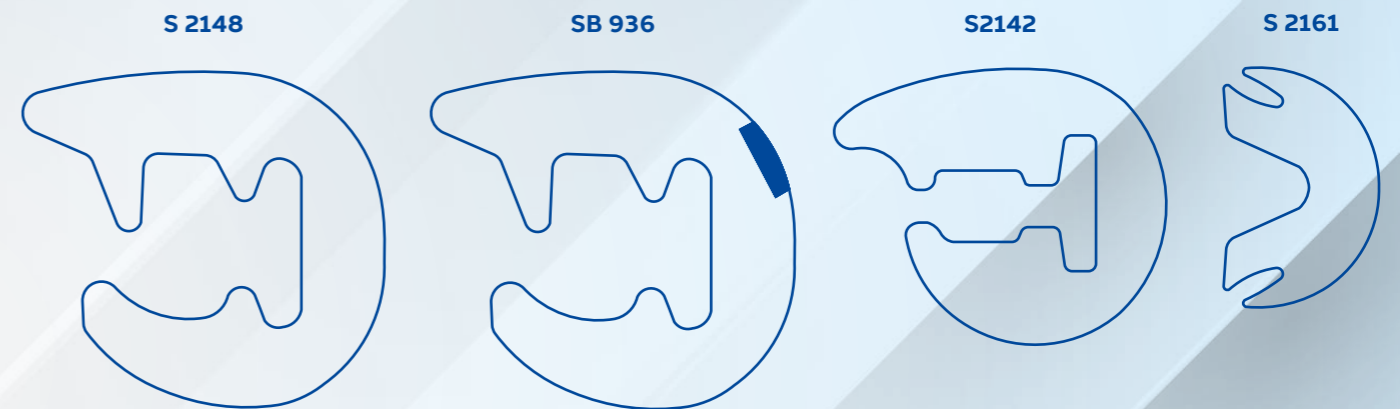

SCALA 1:1 - 1:1 SCALE

□ Flessibile - Flexible ■ Rigido - Rigid

Alcuni esempi dei nostri prodotti / Some examples of our products

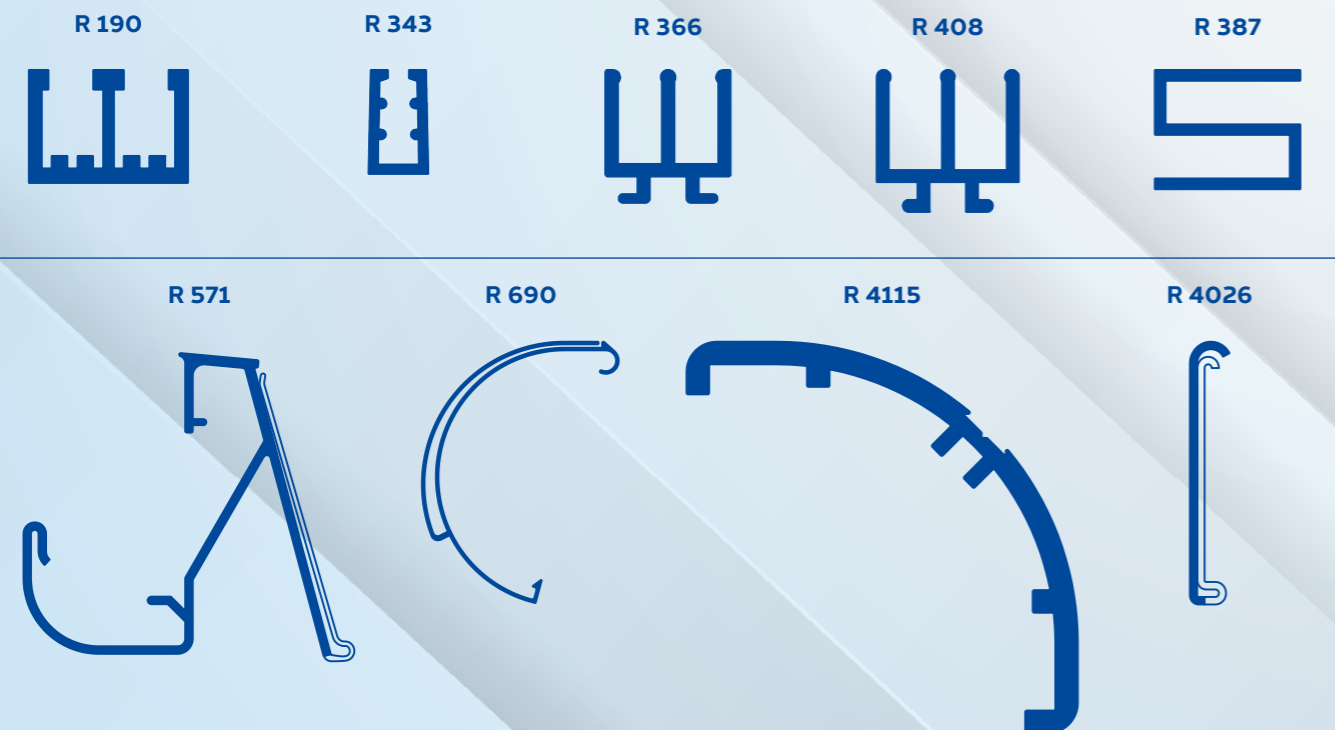

SCALA 1:1 - 1:1 SCALE

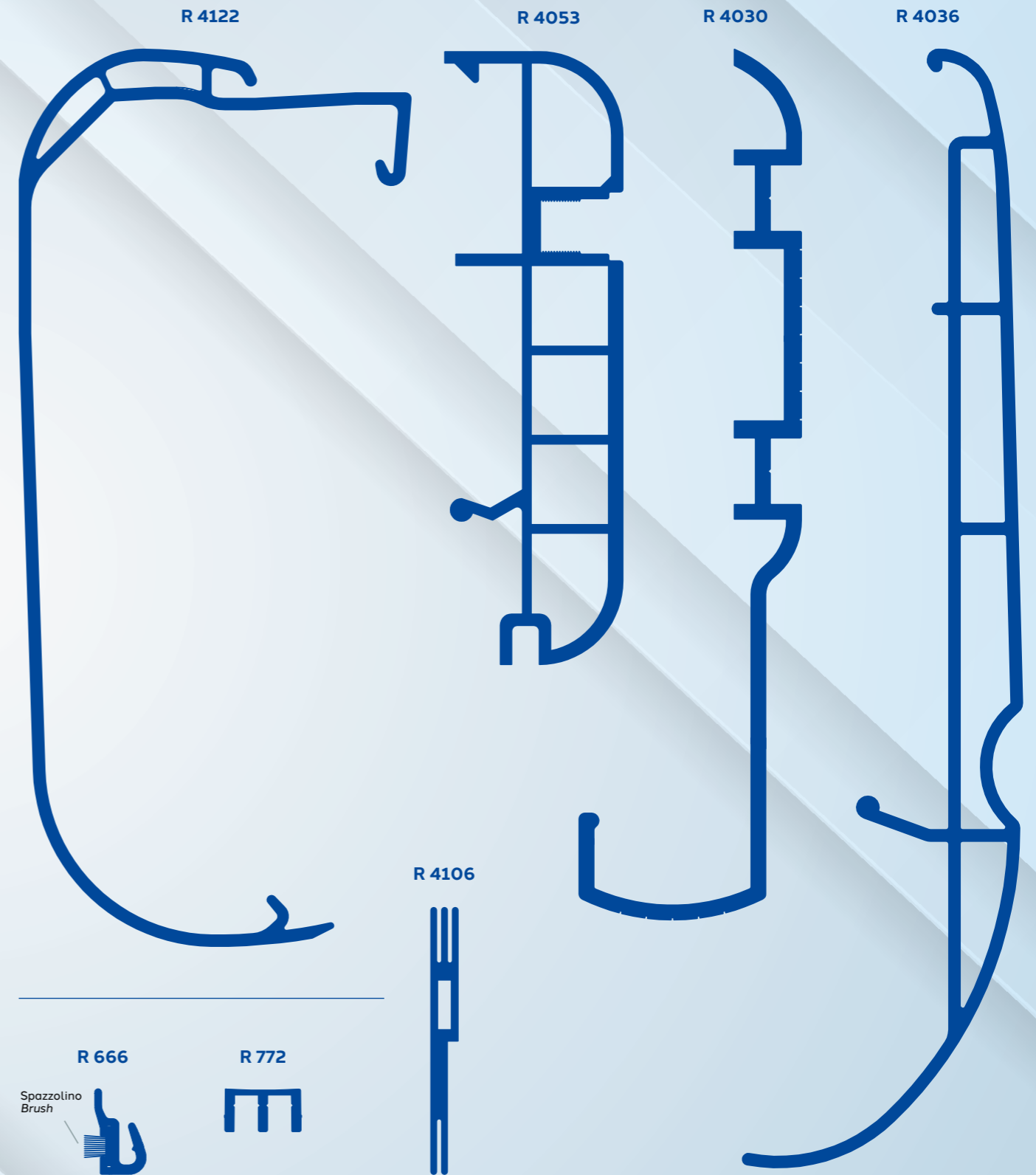

□ Flessibile - Flexible ■ Rigido - Rigid

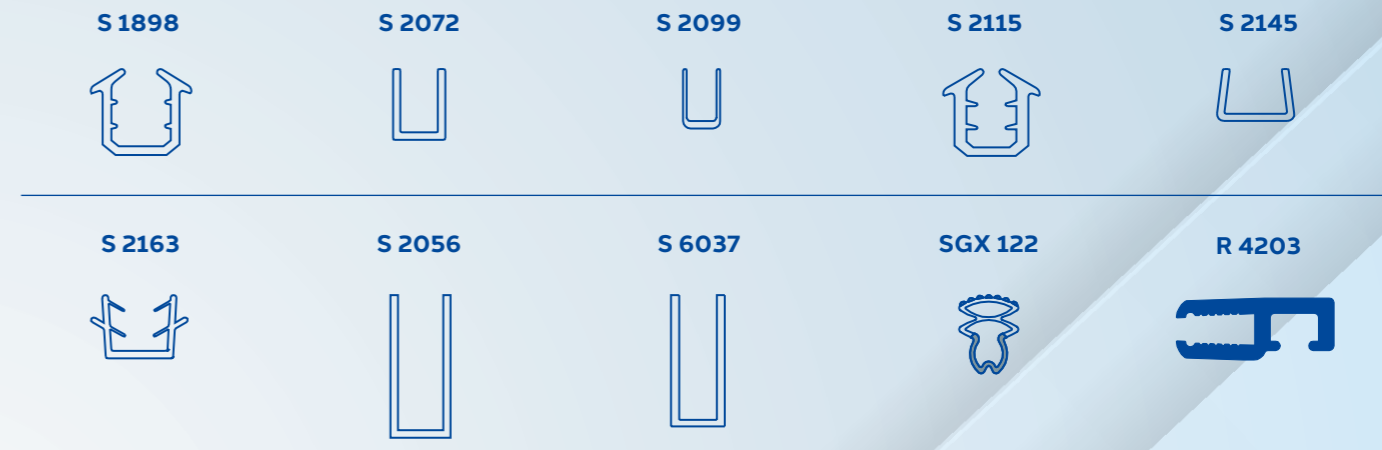
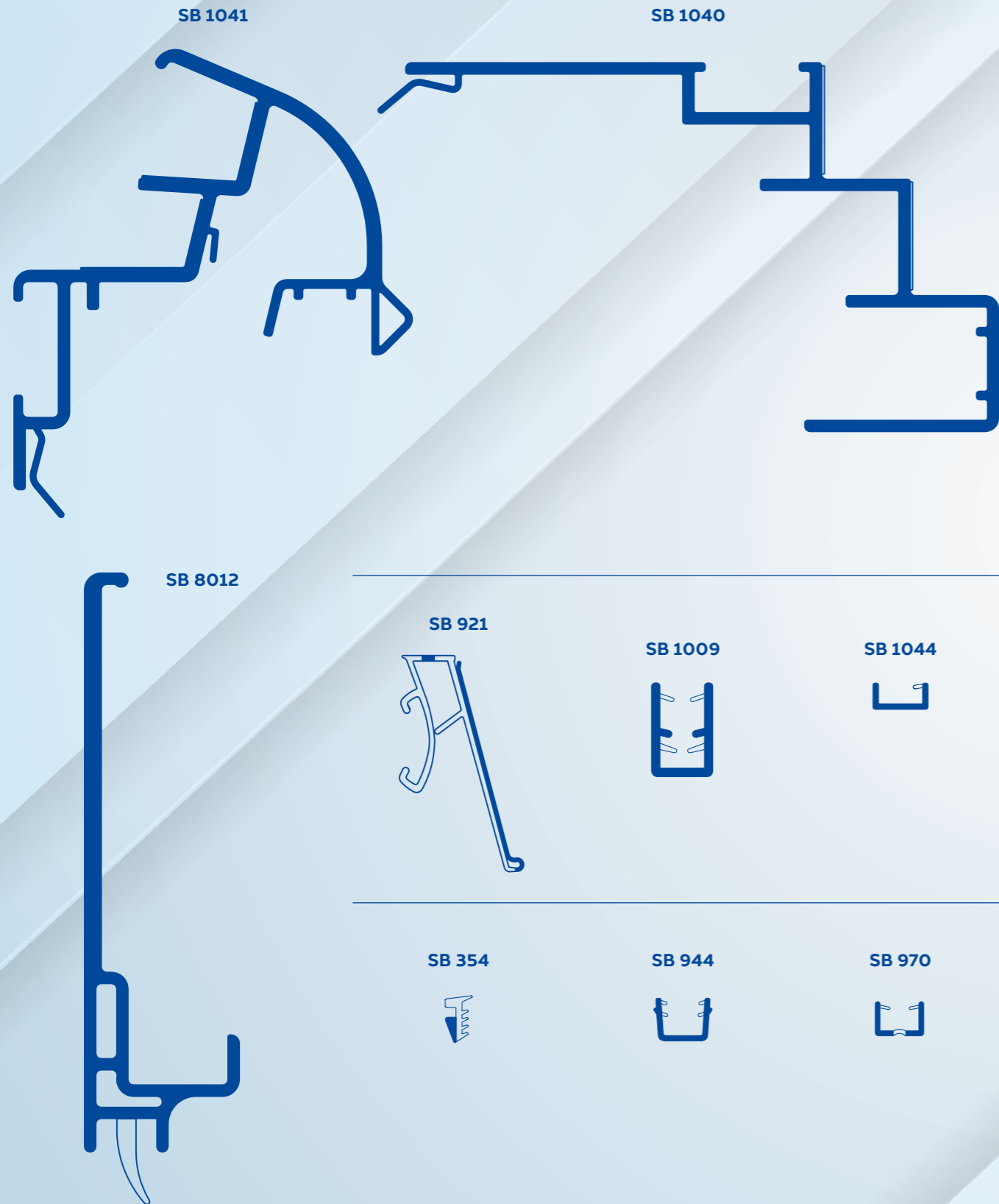

SCALA 1:1 - 1:1 SCALE

□ Flessibile - Flexible ■ Rigido - Rigid



Alcuni esempi dei nostri prodotti / Some examples of our products

KAPPA



MALTA

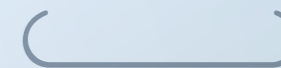

GAMMA



DELTA

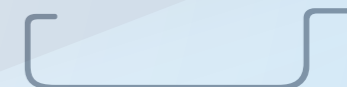
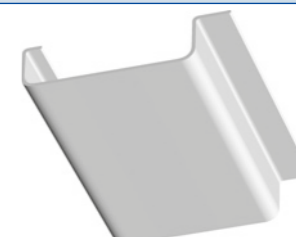

VIP

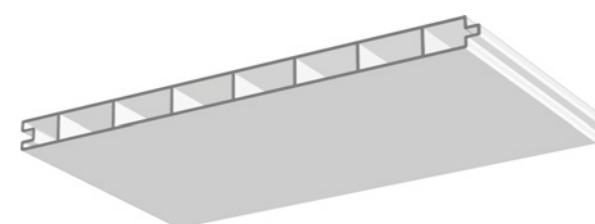

TRIKUM

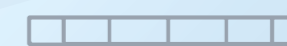
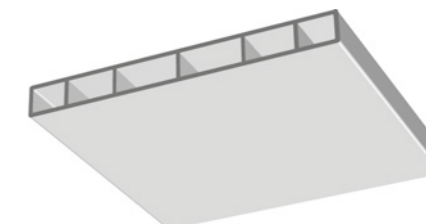

Lombardini srl produce doghe a base di resine termoplastiche in classe VO secondo la normativa UL 94, particolarmente adatte per la realizzazione di pareti divisorie, rivestimenti e controsoffitti.

Il sistema Dogasalplas è completo di accessori ed apposite strutture metalliche in acciaio o in alluminio che consentono una facile posa in opera e una semplice ispezionabilità.

Lombardini srl produces staves in class VO according to UL 94 standard; said items are specially fit for wall partitions, covering and false ceilings.

The Dogasalplas system comes fully equipped with accessories and appropriate metal or aluminium supports for easy mounting and inspection.

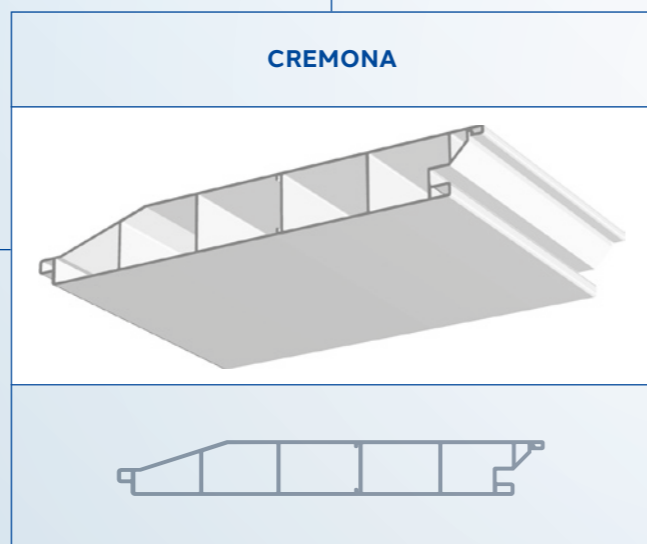
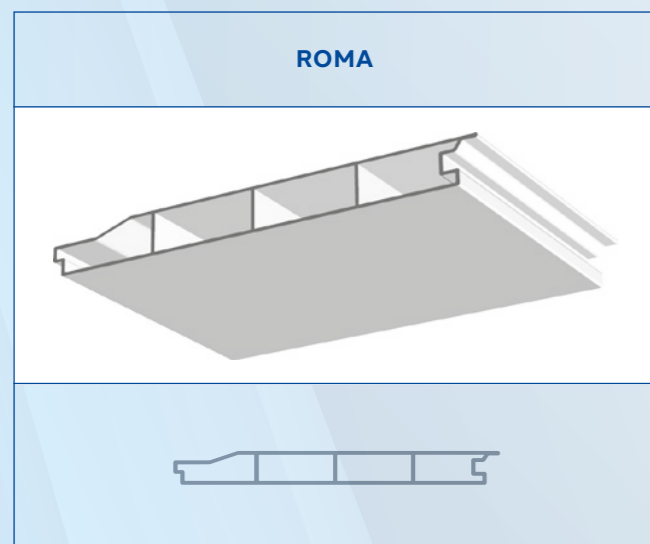

ARTICOLO ITEM	DIMENSIONI mm DIMENSIONS mm	PASSO mm PITCH mm	AUTOPORTANZA mm FREESTANDING CAPABILITY mm
KAPPA	86 X 16	100	1000
MALTA	88 X 16	90/100	600
GAMMA	88 X 24	100	800
DELTA	88 X 24	100	1200
VIP	250 X 16	250	600
TRIKUM	250 X 15	150	600
MILANO	100 X 20	101	1200
GESEI	200 X 35	200	1800
ROMA	200 X 20	200	1200
CREMONA	250 X 35	250	1800

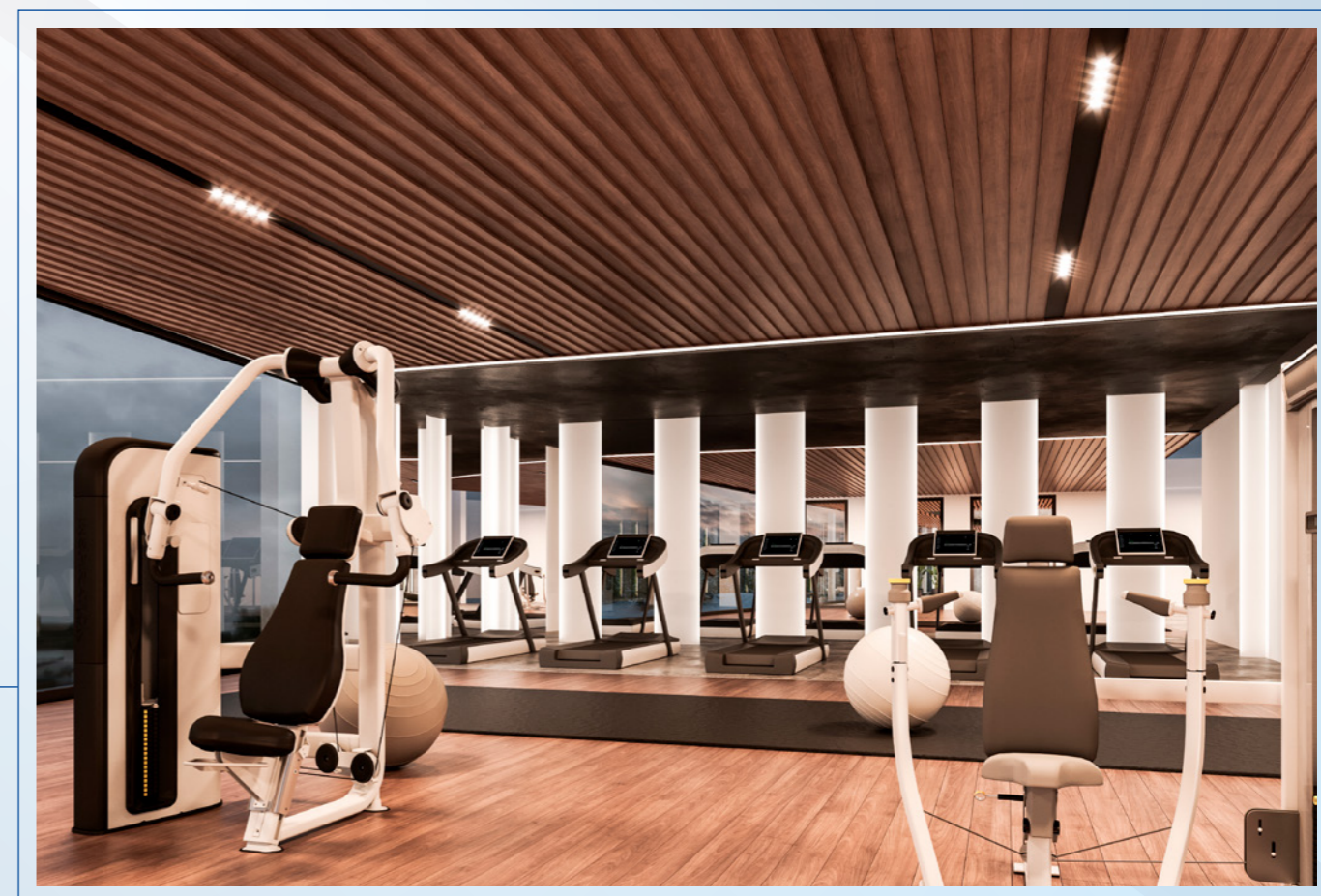

CUSTOM

Le immagini proposte in questo catalogo sono riproduzioni di profili estrusi che Lombardini Srl ha realizzato nel corso degli anni per i propri clienti e sono proposte puramente a fini esemplificativi.

The pictures in this catalogue are provided only as examples of some extruded profiles that Lombardini Srl manufactured along time for its clients.



LOMBARDINI





Lombardini Srl

Via Simone da Corbetta, 158 - 20011 Corbetta (MI) - Italy

Tel.+39 02 97 21 851 - info@lombardinisrl.com

www.lombardinisrl.com